

Volume 1 No.3 31st March, 2025



---

**Patents and Companies Registration Agency**

---

# **ZAMBIA INDUSTRIAL PROPERTY JOURNAL**



**The Official Journal of Patents, Trade Marks & Designs  
for the Patents and Companies Registration Agency**

# **ZAMBIA INDUSTRIAL PROPERTY JOURNAL**

Volume 1 No. 3 31st March, 2025

## **Publication of the Journal as to Statutory Requirements**

THE ZAMBIA INDUSTRIAL PROPERTY JOURNAL is the official journal of industrial property for the Patents and Companies Registration Agency. The authority for its periodic publication is derived from Section 14 of the Patents Act; Section 14 of the Industrial Designs Act; and Section 80 of the Trade Marks Act.

## **Publication of the Journal as to WIPO Standards**

The Journal is published, as far as feasible, in conformity to World Intellectual Property Organization (WIPO) Standards ST 3, 5, 9 - 11, 17 - 20, 60 and 80 and other supporting Standards issued by WIPO for publication of or for presentation of Industrial property (IP) bibliographic data in official IP gazettes. Upgrading of the Journal to the Standards is a standing routine. All codes used in the Journal are explained in the section Key to Codes Used in the Journal.

## **CLOSING TIME FOR ACCEPTANCE OF COPY**

### **Where to send "Copy" intended for Publication**

All proofs intended for publication in the Journal (accompanying appropriate payment properly addressed, see modes of paying for advertisement below under 'Conditions for Advertising') must be forwarded to the Registrar & CEO at either address shown in 'Miscellany' below.

### **Closing Time for Receipt of "Copy"**

Closing time for the receipt by the Registrar & CEO of any 'copy' is 15:30 hours on the last working day of the month immediately preceding the publication date of the issue in which publication is intended. Any 'copy' received thereafter will be held over for publication in the following issue.

## **ADVERTISEMENT AND SUBSCRIPTION RATES**

### **Advertisement Rates**

Advertisements for publication of acceptance proof for a single insertion is K500.00. Advertisements for publication in two or more consecutive issues is K500.00 for the first insertion and K400.00 for every subsequent insertion made in consecutive issues.

All errata advertisements are subject to these charges which are payable, however, only if the mistake necessitating the re-advertisement is not the advertisers shall the re-advertisement be without charge.

## **CONDITIONS FOR ADVERTISING**

### **Authorization for Advertisement**

No advertisement will be accepted for publication in the Journal unless it has been approved, and it actually carries proof of such authorization, by the Registrar & CEO, as the case may be, for publication.

### **Responsibility for consequence of Advertisement**

Neither the Government of the Republic of Zambia nor the Patents and Companies Registration Agency, accepts any responsibility for cases arising from errors or omissions in any advertisement and neither does the Government nor the Patents and Companies Registration Agency, guarantee the accuracy of any particular publication in the journal.

### **Modes of Paying for Subscription Advertisement**

All payments for advertising in the Journal must be made to the Patents and Companies Registration Agency. No cash payments shall be accepted.

## **Proofs for Label/Device Marks to be Accompanied by an Exact Representation**

Every proof submitted for publication of a label/device trade mark must be accompanied by a specimen representation of the label/device trade mark corresponding, in all material respects, to the representation submitted previously to the Patents and Companies Registration Agency on the relevant type of application. Any label/device trade mark proof not accompanied by this specimen or accompanied by a bad photocopy of this specimen will not be accepted for publication.

## **MISCELLANY**

### **Address of Enquiry or of Correspondence**

All-enquiry or correspondence concerning all matters on patents, trademarks, industrial designs and any other aspect of intellectual property in Zambia, or about anything published or intended to be published in the Journal should be presented either in person, to the Intellectual Property Department, 1st Floor North Wing, PACRA House, Plot No. 8471, Haile Selassie Avenue, Longacres, Lusaka or by post to the Registrar & CEO, Patents and Companies Registration Agency, P.O. Box 32020, Lusaka,(10101), Zambia.

### **General Advertisement of Employment, Meetings(etc.) in the Industrial Property Field**

Readers of this Journal are being informed that advertisements are accepted for publication in the Journal concerning any general news or information in the intellectual property field such as employment offered or sought, meetings, etc. Submissions and enquiries should be made to the Patents and Companies Registration Agency at the above address.

## **THIS JOURNAL**

---

The Zambia Industrial Property Journal is a national publication of the Patents and Companies Registration Agency (“the Agency”). It is published, only in English, on the last day of every month.

### **EVERY CORRESPONDENCE TO THE AGENCY TO BE ADDRESSED TO:**

The Registrar & Chief Executive Officer

## **GENDER REPRESENTATION**

Any masculine terms used in this publication include females. [Aiding interpretation of section 4(2) of the Interpretation and General Provisions Act (Cap. 2).]

## **FRONT COVER**

Depicts the Label of the Patents and Companies Registration Agency (PACRA) an executive agency of the Ministry of Commerce, Trade and Industry (MCTI).

## **BACK COVER**

The maxim appearing on the verso of the back cover is used in this publication to underline the importance of any official intellectual property gazette, such as this journal, as a tool for location of the source, and dissemination, of, as in this case, industrial property information.

# CONTENTS

ARIPO-PATENTS APPLICATIONS FILED DESIGNATING ZAMBIA IN FEBRUARY 2025	Error! Bookmark not defined.
ARIPO-PATENTS GRANTED IN FEBRUARY DESIGNATING ZAMBIA.....	11
PATENT APPLICATIONS LODGED WITH PROVISIONAL SPECIFICATION (BB/CA).....	19
APPLICATIONS FOR REGISTRATION OF TRADE MARKS LODGED DURING FEBRUARY 2025 (AA).....	21
ACCEPTED APPLICATIONS FOR REGISTRATION OF TRADE MARKS - ABSOLUTE. (BB/CA)	Error! Bookmark not defined.40
ACCEPTED APPLICATIONS FOR REGISTRATION OF TRADE MARKS - CONDITIONAL. (BB/CA)	Error! Bookmark not defined.61
ACCEPTED TRADE MARK APPLICATIONS FILED FOR REGISTRATION UNDER THE MADRID PROTOCOL FOR THE REGISTRATION OF INTERNATIONAL MARKS.(CA) .....	71
TRADE MARKS REGISTERED. (FG). .....	112
TRADE MARK REGISTRATIONS RENEWED IN FEBRUARY 2025. (ND).....	131
TRADE MARK REGISTRATIONS NOT RENEWED FOR FEBRUARY, 2025. (KC) .....	143
TRADE MARK REGISTRATIONS LAPSED FOR NON-RENEWAL. (MM) .....	192
INDUSTRIAL DESIGNS FILED IN FEBRUARY 2025.....	216
ARIPO-REGISTERED DESIGN FILES DESIGNATING ZAMBIA IN FEBRUARY 2025 .....	218
ERRATA.....	221
KEY TO CODES USED IN THIS JOURNAL.....	225
LETTER CODES (STATUS CODES) FOR HEADINGS OF ANNOUNCEMENTS (WIPO ST.17). .....	226

ARIPO FILINGS

ARIPO-PATENTS APPLICATIONS FILED DESIGNATING ZAMBIA IN FEBRUARY 2025

(11) AP/P/2016/009439; (22) 12.02.2015  
(31) PCT/IB2015/001410  
(51) Int. Cl. E02D31/00(2006.01); E01C3/00(2006.01); E01C3/04(2006.01); E01B2/00(2006.01)  
(54) **GEOCELL WITH IMPROVED COMPACTION AND DEFORMATION RESISTANCE**  
(73) GEOTECH TECHNOLOGIES LTD.

---

AP/P/2020/012479; 30.11.2018  
(31) PCT/IB2015/001410  
(51) Int. Cl. B60P1/28(2006.01); B60R13/01(2006.01)  
(54) **TRUCK BOX**  
(73) METSO FINLAND OY

---

(11) AP/P/2020/012635; (22) 30.11.2018  
(31) PCT/EP2016/073970  
(51) Int. Cl. G10L19/008(2013.01); G10L19/24(2013.01)  
(54) **LAYERED CODING FOR COMPRESSED SOUND OR SOUND FIELD REPRESENTATIONS**  
(73) DOLBY INTERNATIONAL AB.

---

(11) AP/P/2021/012982; (22) 01.08.2019  
(31) PCT/GB2019/052154  
(51) Int. Cl. H04N19/36(2014.01); H04N19/60(2014.01); H04N19/33(2014.01); H04N19/132(2014.01); H04N19/167(2014.01); H04N19/172(2014.01); H04N19/59(2014.01); H04N19/61(2014.01)  
(54) **TRANSFORMATIONS FOR SIGNAL ENHANCEMENT CODING**  
(73) V-NOVA INTERNATIONAL LIMITED

---

(11) AP/P/2021/013026; (22) 11.09.2019

(31) PCT/ES2019/070600

(51) Int. Cl. F25D31/00(2006.01)

(54) **DEVICE FOR THE RAPID CHILLING OF CANNED DRINKS**

(73) PULSACCLASS SAS.

---

(11) AP/P/2021/013098; (22) 12.10.2018

(31) PCT/CN2018/110155

(51) Int. Cl. C07D417/14(2006.01)

(54) **CONJUGATION LINKERS CONTAINING 2,3- DIAMINOSUCCINYL GROUP**

(73) HANGZHOU DAC BIOTECH CO., LTD

---

(11) AP/P/2021/013293; (22) 27.11.2019

(31) PCT/EP2019/082807

(51) Int. Cl. C10J3/26(2006.01); C10J3/72(2006.01); C10J3/08(2006.01); C10J3/66(2006.01)

(54) **REACTOR AND PROCESS FOR GASIFYING AND/OR MELTING OF FEED MATERIALS**

(73) KBI INVEST & MANAGEMENT AG

---

(11) AP/P/2021/013306; (22) 01.06.2017

(31) PCT/EP2017/063385

(51) Int. Cl. A61K31/352(2006.01); A61K8/00(2006.01); D21H25/00(2006.01); A23L5/00(2016.01); A61P31/04(2006.01)

(54) **CANNABIDIOL COMPOSITIONS AND USES THEREOF**

(73) PHARMOTECH SA.

---

(11) AP/P/2021/013361; (22) 15.01.2020

(31) PCT/IB2020/050283

(51) Int. Cl. A01N43/56(2006.01); A01N47/24(2006.01); A01P3/00(2006.01)

(54) **COMPOSITION COMPRISING TOLFENPYRAD AND PYRACLOSTROBIN**

(73) PI INDUSTRIES LIMITED

---

(11) AP/P/2021/013691; (22) 19.05.2020

(31) PCT/US2020/033602

(51) Int. Cl. A61K47/68(2017.01)

(54) **MCL-1 INHIBITOR ANTIBODY-DRUG CONJUGATES AND METHODS OF USE**

(73) NOVARTIS AG.

---

(11) AP/P/2022/013903; (22) 27.08.2019

(31) PCT/EP2019/072843

(51) Int. Cl. C12P7/22(2006.01); C12P17/06(2006.01); A61K31/352(2006.01)

(54) **CANNABINOID CONCENTRATE AND ISOLATE, METHOD OF OBTAINING THE SAME AND USE THEREOF**

(73) HERBOLEA BIOTECH S.P.A.

---

(11) AP/P/2022/013916; (22) 17.08.2020

(31) PCT/PL2020/000069

(51) Int. Cl. C22B3/16(2006.01); B01J20/22(2006.01); C22B11/00(2006.01)

(54) **METHOD OF SEPARATING GRAINS OF VALUABLE MINERALS, PRECIOUS METALS, RARE-EARTH METALS, PRECIOUS AND SEMIPRECIOUS STONES FROM NATURAL ORES IN THE AQUATIC ENVIRONMENT BY MEANS OF THE PHENOMENON OF ADHESION**

(73) CIECHULSKI Andrzej.

---

(11) AP/P/2022/013987; (22) 06.10.2020

(31) PCT/EP2020/077919

(51) Int. Cl. F24S20/20(2018.01); F24S10/70(2018.01); F24S23/74(2018.01); F24S80/60(2018.01) (54) **HEAT RECEIVER FOR URBAN CONCENTRATED SOLAR POWER**

(73) SUNCOM ENERGY B.V.

(11) AP/P/2022/014028; (22) 30.10.2020

(31) PCT/GB2020/052750

(51) Int. Cl. F16K31/385(2006.01); E03B7/07(2006.01)



(54) **LIQUID PRESSURE REDUCING VALVE**

(73) POLYMER TECHNOLOGIES LIMITED.

(11) AP/P/2022/014140; (22) 16.12.2020

(31) PCT/EP2020/086427

(51) Int. Cl. A61K 47/00 (2006.01)

(54) **WEAR PART, BUCKET AND METHOD**

(73) SANDVIK MINING AND CONSTRUCTION OY.

---

(11) AP/P/2022/014424; (22) 03.06.2020

(31) PCT/FI2020/050390

(51) Int. Cl. B01D25/127(2006.01); B01D25/164(2006.01); B01D25/21(2006.01); B01D25/30(2006.01); B01D25/12(2006.01)

(54) **AN OUTLET PIECE ASSEMBLY**

(73) METSO FINLAND OY.

---

(11) AP/P/2022/014503; (22) 04.06.2021

(31) PCT/IB2021/054919

(51) Int. Cl. C07D239/90(2006.01); C07D401/12(2006.01); C07D403/12(2006.01); C07D405/12(2006.01); A61P35/00(2006.01); A61K31/517(2006.01)

(54) **DIHYDROQUINAZOLINON COMPOUNDS FOR THE TREATMENT OF BRAF ASSOCIATED DISEASES AND DISORDERS**

(73) ARRAY BIOPHARMA INC.

---

(11) AP/P/2022/014521; (22) 12.05.2021

(31) PCT/IB2021/054055

(51) Int. Cl. A61K9/00(2006.01); A61K47/12(2006.01); A61P7/08(2006.01)

(54) **COMBINED HYPEROSMOLAR SOLUTION FOR INFUSION.**

(73) M.T.K. MEDICAL CENTER LIMITED LIABILITY COMPANY.

(11) AP/P/2022/014555; (22) 4.06.2021

(31) PCT/EP2021/065923

(51) Int. Cl. B01D61/02(2006.01)

C01B25/234(2006.01)

(54) **PROCESS FOR PURIFYING A PHOSPHATE CONTAINING ACIDIC SOLUTION COMPRISING IMPURITIES AND APPARATUS FOR**

(73) PRAYON.

---

(11) AP/P/2023/014815;

(22) 13.04.2023

(31) PCT/US2023/067927

(51) Int. Cl. G01R 33/07G01D 5/12; (G20012D3. 051/0)6G01R33/00); (G20012B3.70/10); (OG01P5/00)

(54) **A MAGNETIC SENSOR**

(73) CONLOG (PTY) LTD.

---

(11) AP/P/2023/015179;

(22) 07.07.2022

(31) PCT/ZA2022/050028

(51) Int. Cl. F42D3/04(2006.01); F42D1/05(2006.01); F42B3/10(2006.01); F42D1/055(2006.01); F42C15/42(2006.01); F42D1/02(2006.01)

(54) **WIRELESS INITIATING ARRANGEMENT**

(73) DETNET SOUTH AFRICA (PTY) LTD.

---

(11) AP/P/2023/015180;

(22) 07.07.2022

(31) PCT/ZA2022/050029

(51) Int. Cl. F42D3/04(2006.01); F42D1/05(2006.01); F42B3/10(2006.01); F42D1/055(2006.01); F42C15/42(2006.01); F42D1/02(2006.01);

(54) **WIRELESS DETONATOR ARRANGEMENT**

(73) DETNET SOUTH AFRICA (PTY) LTD

ARIPO FILINGS

ARIPO – PATENTS GRANTED DESIGNATING ZAMBIA IN FEBRUARY 2025

(11) AP 7579; (22) 25.03.2016

(21) AP/P/2017/010167;

(31) PCT/IB2016/051704

(51) Int. Cl. G01V9/00(2006.01)

**(54) A METHOD AND DEVICE FOR DETECTING A MATERIAL**

(73) KRUGEL Daniel Rudolph.

---

(11) AP 7624; (22) 03.07.2018

(21) AP/P/2020/012201;

(31) PCT/SE2018/050726

(51) Int. Cl. C12Q1/48(2006.01); C12Q1/70(2006.01); G01N33/94(2006.01)

**(54) METHOD FOR ASSESSING SUSCEPTIBILITY OF A VIRUS TO TREATMENT BY MEASURING ENZYME ACTIVITY AND A SYSTEM THEREFORE**

(73) CAVIDI AB.

---

(11) AP 7581; (22) 21.11.2017

(21) AP/P/2020/012470; (31) PCT/EP2017/079877

(51) Int. Cl. A01N25/34(2006.01); A01N53/00(2006.01); B65D65/42(2006.01); B65D30/08(2006.01); B65D81/28(2006.01)

**(54) A HERMETIC, INSECTICIDAL FOOD STORAGE BAG, USE OF IT AND A METHOD FOR ITS PRODUCTION**

(73) VESTERGAARD SÁRL.

---

(11) AP 7632; (22) 31.03.2017

(21) AP/P/2020/012522; (31) PCT/US2017/025573

(51) Int. Cl. A61K31/7068(2006.01); A61K35/17(2015.01); A61K38/17(2006.01) A61K39/00(2006.01); A61K39/395(2006.01); A61K45/06(2006.01)

**(54) CHIMERIC RECEPTORS AND METHODS OF USE THEREOF**

(73) KITE PHARMA, INC.

---

(11) AP 7608; (22) 30.08.2017

(21) AP/P/2020/012692; (31) PCT/US2019/026840

(51) Int. Cl. A61P35/00(2006.01); C07K16/28(2006.01); C07K16/30(2006.01)

(54) **CHIMERIC RECEPTORS TO DLL3 AND METHODS OF USE THEREOF**

(73) AMGEN INC.

---

(11) AP 7634; (22) 13.03.2019

(21) AP/P/2020/012701; (31) PCT/US2019/022062

(51) Int.Cl.A61K31/4738(2006.01);A61K31/7084(2006.01);A61K31/716(2006.01); 61K39/00(2006.01)

(54) **BETA GLUCAN AND CD40 AGONIST COMBINATION IMMUNOTHERAPY**

(73) HIBERCELL, INC.

---

(11) AP 7609; (22) 02.07.2019

(21) AP/P/2020/012850; (31) PCT/US2019/040342

(51) Int. Cl. A61P31/18(2006.01); C07K16/10(2006.01)

(54) **ANTIBODIES THAT TARGET HIV GP120 AND METHODS OF USE**

(73) GILEAD SCIENCES, INC.

---

(11) AP 7583; (22) 05.11.2015

(21) AP/P/2021/013033; (31) PCT/EP2015/075816

(51) Int. Cl. A61K9/00(2006.01) A61K31/122(2006.01) A61K31/17(2006.01)

(54) **A VETERINARY INJECTABLE FORMULATION**

(73) BIMEDA AMEA LIMITED.

---

(11) AP 7586; (22) 31.10.2019

(21) AP/P/2021/013211; (31) PCT/US2019/059267

(51) Int. Cl. E02F9/24(2006.01); E02F9/28(2006.01)

(54) **WEAR ASSEMBLY**

(73) ESCO GROUP LLC.

---

(11) AP 7587; (22) 31.10.2019

(21) AP/P/2021/013222; (31) PCT/AU2019/051206

(51) Int. Cl. E21B47/00(2012.01); E21B49/00(2006.01); G01V99/00(2009.01); G01V1/28(2006.01) G01V1/40(2006.01); G01V3/18(2006.01); G01V3/38(2006.01); G01V5/12(2006.01)

(54) **A METHOD AND SYSTEM FOR SAMPLE CLASSIFICATION**

(73) TECHNOLOGICAL RESOURCES PTY. LIMITED.

---

(11) AP 7588; (22) 02.12.2019  
(21) AP/P/2021/013273;  
(31) PCT/CH2019/050027  
(51) Int. Cl. A24C5/18(2006.01); A24C5/39(2006.01)  
(54) **CIGARETTE-MAKING MACHINE AND METHOD FOR PRODUCING CIGARETTES**  
(73) KOCH Roger [for KENYA ONLY].

---

(11) AP 7610; (22) 31.01.2019  
(21) AP/P/2021/013386; (31) PCT/CN2019/074176  
(51) Int. Cl. A61K47/50(2017.01); C07K7/64(2006.01); A61P35/00(2006.01)  
(54) **A CONJUGATE OF AN AMATOXIN ANALOG WITH BRANCHED LINKERS**  
(73) HANGZHOU DAC BIOTECH CO., LTD.

---

(11) AP 7622; (22) 03.04.2020  
(21) AP/P/2021/013528;  
(31) PCT/US2020/026629  
(51) Int. Cl. B60K1/04(2006.01); B60L53/80(2019.01); B60L58/18(2019.01)  
(54) **INTERCHANGEABLE ENERGY DEVICE FOR ELECTRIC VEHICLE**  
(73) SANDVIK MINING AND CONSTRUCTION OY.

---

(11) AP 7627; (22) 19.03.2018  
(21) AP/P/2021/013657;  
(31) PCT/US2018/023183  
(51) Int. Cl. G06F17/10(2006.01); G10L19/02(2013.01); G10L19/22(2013.01); G10L19/24(2013.01); G10L19/26(2013.01)  
(54) **BACKWARD-COMPATIBLE INTEGRATION OF HARMONIC TRANSPOSER FOR HIGH FREQUENCY RECONSTRUCTION OF AUDIO SIGNALS**  
(73) DOLBY INTERNATIONAL AB.

---

(11) AP 7600; (22) 04.06.2020  
(21) AP/P/2021/013659  
(31) PCT/US2020/036096  
(51) Int. Cl. B60K1/04(2006.01); B60S5/06(2006.01)

(54) **BATTERY LOAD MECHANISM FOR ELECTRIC LHD MINING MACHINE**

(73) SANDVIK MINING AND CONSTRUCTION OY.

---

(11) AP 7603; (22) 05.06.2020

(21) AP/P/2021/013666

(31) PCT/EP2020/065639

(51) Int. Cl. A61K31/519(2006.01); A61K9/00(2006.01); A61P35/00(2006.01); A61K45/06(2006.01)

(54) **METHODS OF TREATING CANCER USING PRMT5 INHIBITORS**

(73) JANSSEN PHARMACEUTICA NV.

---

(11) AP 7601; (22) 28.05.2020

(21) AP/P/2021/013692; (31) PCT/US2020/034909

(51) Int. Cl. C02F1/32(2006.01); C02F1/52(2006.01); C02F1/54(2006.01)

(54) **LOW COST AND SANITARY EFFICIENT SYSTEM AND METHOD THAT CREATES TWO DIFFERENT TREATMENT ZONES IN LARGE WATER BODIES TO FACILITATE DIRECT CONTACT RECREATIONAL ACTIVITIES**

(73) CRYSTAL LAGOONS TECHNOLOGIES, INC.

---

(11) AP 7611; (22) 14.07.2020

(21) AP/P/2022/013763; (31) PCT/CN2020/101901

(51) Int. Cl. A01N43/40(2006.01); A01N43/78(2006.01); A01N43/56(2006.01); A01N43/54(2006.01) A01N47; 12(2006.01) A01P13/00(2006.01)

(54) **HERBICIDAL COMPOSITION COMPRISING R- PYRIDYLOXYCARBOXYLIC ACID AND DERIVATIVE AND AN APPLICATION THEREOF**

(73) QINGDAO KINGAGROOT CHEMICAL COMPOUND CO., LTD.

---

(11) AP 7594; (22) 22.06.2020

(21) AP/P/2022/013791;

(31) PCT/DE2020/200051

(51) Int. Cl. E04B1/58(2006.01)

(54) **COUPLING DEVICE FOR THE MODULAR CONSTRUCTION OF STRUCTURES OR OBJECTS**

(73) PACARADA Elvir.

---

(11) AP 7628; (22) 29.07.2020

(21) AP/P/2022/013847;

(31) PCT/GB2020/051815

(51) Int. Cl. C05D1/02(2006.01); C05G5/12(2020.01); C05G5/30(2020.01)

(54) **POLYHALITE COMPOSITE FERTILISER PELLETT**

(73) YORK POTASH LTD.

---

(11) AP 7595; (22) 03.10.2017

(21) AP/P/2022/013902; (31) PCT/US2017/054920

(51) Int. Cl. H04N19/186(2014.01); H04N19/70(2014.01); H04N19/46(2014.01); H04N21/235(2011.01); H04N21/84(2011.01)

(54) **SOURCE COLOR VOLUME INFORMATION MESSAGING**

(73) DOLBY LABORATORIES LICENSING CORPORATION.

---

(11) AP 7596; (22) 19.07.2021

(21) AP/P/2022/014094; (31) PCT/IB2021/056487

(51) Int. Cl. G06Q40/02(2012.01); G06Q40/06(2012.01); H04L29/08(2006.01)

(54) **SYSTEM AND METHOD FOR REMOTE PROVISION, DISBURSEMENT AND COLLECTION OF SECURED LOANS**

(73) CHANNEL TECHNOLOGIES FZE.

---

(11) AP 7602; (22) 14.12.2020

(21) AP/P/2022/014129; (31) PCT/US2020/064765

(51) Int. Cl. C07D217/04(2006.01); C07D401/14(2006.01); A61K31/44(2006.01); C07D471/04(2006.01); C07D487/04(2006.01); A61K31/519(2006.01); A61K31/4725(2006.01); A61K31/437(2006.01)

(54) **PRMT5 INHIBITORS**

(73) MERCK SHARP & DOHME LLC.

---

(11) AP 7598; (22) 17.06.2019

(21) AP/P/2022/014216; (31) PCT/EP2019/065890

(51) Int. Cl. B65D51/16(2006.01); B65D53/02(2006.01); B65D17/28(2006.01)

(54) **METALLIC CAN END**

(73) TOP CAP HOLDING GMBH.

---

(11) AP 7599; (22) 17.04.2020

(21) AP/P/2022/014232; (31) PCT/FI2020/050254

(51) Int. Cl. B01D25/164(2006.01); B01D25/168(2006.01); B01D25/21(2006.01); B01D25/28(2006.01)

(54) **FILTER DIAPHRAGM FOR HORIZONTAL PLATE AND FRAME - TYPE FILTER**

(73) METSO OUTOTEC FINLAND OY.

---

(11) AP 7630; (22) 17.02.2021  
(21) AP/P/2022/014303; (31) PCT/EP2021/053887  
(51) Int. Cl. A61B18/14(2006.01); A61B17/32(2006.01); A61B17/3205(2006.01); A61B17/3207(2006.01); A61B18/00(2006.01)  
(54) **EXCISION APPARATUS**  
(73) COEMAN Dirk Carl Luc.

---

(11) AP 7606; (22) 20.05.2021  
(21) AP/P/2022/014515; (31) PCT/EP2021/063557  
(51) Int. Cl. A01N37/42(2006.01); A01N25/04(2006.01); A01N25/30(2006.01); A01P21/00(2006.01)  
(54) **NEW TRINEXAPAC-ETHYL MICROEMULSION COMPOSITIONS**  
(73) SYNGENTA CROP PROTECTION AG.

---

(11) AP 7612; (22) 26.05.2020  
(21) AP/P/2022/014588; (31) PCT/IB2020/054992  
(51) Int. Cl. C08L95/00(2006.01)  
(54) **ASPHALTIC MIXTURE CONDITIONER, CONDITIONED ASPHALTIC PAVING MIXTURE, THEIR PROCESSES OF PREPARATION, THEIR USES IN PAVING SURFACES, PAVED SURFACES AND SYSTEM TO PREPARE AN ASPHALTIC MIXTURE CONDITIONER**  
(73) ASFALTO LIQUIDO TECNOLOGIA EXTREMA ALTEX SOCIEDAD ANONIMA.

---

(11) AP 7620; (22) 03.06.2021  
(21) AP/P/2022/014595; (31) PCT/US2021/035770  
(51) Int. Cl. A01N43/16(2006.01); A61N63/22(2006.01); C07D311/22(2006.01)  
(54) **COMPOUNDS AND METHODS FOR STIMULATING PLANTS**  
(73) SOUND AGRICULTURE COMPANY.

---

(11) AP 7613; (22) 27.07.2021  
(21) AP/P/2023/014716; (31) PCT/US2021/043333  
(51) Int. Cl. A61M16/06(2006.01); A61M16/00(2006.01); A61M16/20(2006.01); A62B7/04(2006.01)  
(54) **AUTOMATIC SYSTEM FOR THE CONSERVATION OF OXYGEN AND OTHER SUBSTANCES**  
(73) OXFO CORPORATION.

---



(11) AP 7614; (22) 22.03.2022  
(21) AP/P/2023/014743;  
(31) PCT/ZA2022/050015  
(51) Int. Cl. B66C1/10(2006.01); B65D88/06(2006.01); B66C13/08(2006.01); B66F9/18(2006.01)  
(54) **A CARRIER ASSEMBLY**  
(73) VDM SUPPLY CHAIN SOLUTIONS (PTY) LTD.

---

(11) AP 7615; (22) 07.09.2021  
(21) AP/P/2023/014756;  
(31) PCT/AT2021/060317  
(51) Int. Cl. F01K7/32(2006.01); F01K19/10(2006.01); F01K7/12(2006.01); F01K3/14(2006.01); F01K25/10(2006.01)  
(54) **APPARATUS AND METHOD FOR CONVERTING THERMAL ENERGY**  
(73) ENERSCALE GMBH.

---

(11) AP 7616; (22) 22.03.2022  
(21) AP/P/2023/014766;  
(31) PCT/ZA2022/050015  
(51) Int. Cl. B66C1/10(2006.01); B65D88/06(2006.01); B66C13/08(2006.01); B66F9/18(2006.01)  
(54) **A CARRIER ASSEMBLY AND A PIVOTING APPARATUS FOR A MATERIAL HANDLING SYSTEM**  
(73) VDM SUPPLY CHAIN SOLUTIONS (PTY) LTD.

---

(11) AP 7618; (22) 02.09.2021  
(21) AP/P/2023/014797.  
(31) PCT/AU2021/051021  
(51) Int. Cl. G01N23/221(2006.01); G21G1/12(2006.01); G01N23/2208(2018.01)  
(54) **IMPROVEMENTS IN GAMMA- ACTIVATION ANALYSIS MEASUREMENTS**  
(73) CHRYSOS CORPORATION LIMITED.

---

(11) AP 7633; (22) 28.12.2021  
(21) AP/P/2023/015110;  
(31) PCT/EP2021/087701  
(51) Int. Cl. A47J31/18(2006.01); A47J31/42(2006.01)  
(54) **METHOD AND DEVICE FOR PRODUCING A SUSPENSION**



## STATUTORY NOTICES UNDER THE PATENTS ACT (NO. 40)

### PATENT APPLICATIONS LODGED WITH PROVISIONAL SPECIFICATIONS. (BB/CA)

Specifications of the undermentioned applications for letters have been accepted by the Registrar of Patents and can now be inspected by the public at the Patents Office, at a charge, during business hours. Photocopies of these specifications, drawings and other documents of these applications are obtainable, at a charge, from the Patent Office. In terms of section 56 of the Patents Act, any person interested may within three months of the date of publication hereof (or within such further period as the Registrar may, on application to him within that period allow or, with the consent of the patent applicant, at any time before the grant of a patent on the application) object to the grant of the patent by filing at the Patent Office a notice of opposition on Patents Form No. 12

(11) 1/2025;

(24) 03.02.2025

(51) Int. CL. B64C 33/02

(54) Valved Flapping Wing.

(73) (75) Ivor Katulwende Musumali, Off Mutale Road, Mukulumpe Area, Kasama, Northern Province Zambia.

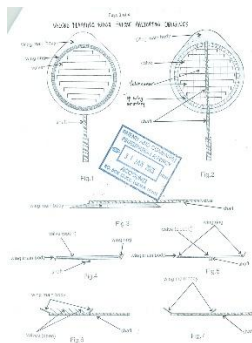

(57) This invention is a lightweight wing with valves covering its surface which only permit airflow in one direction as the wing flaps up and down or consequently makes the entire wing to move in one direction. The main parts of wing are the wing main body, wing shaft, wing cross shaft, valve material, wing ring, and valve arresters. This wing can be used as a wing on a flying craft i.e. by installing one or more on both sides of the craft to enable it achieve lift and get airborne as well as propel it forward, backwards or indeed in any other direction as the wing continuously flaps. The wing can also be fitted on hot air balloons and airships to enhance maneuverability, propulsion and steering. It can further be used as a wing underwater to achieve similar effects and as a propeller to provide propulsion and/or steering for water surface vessels and on land vehicles to achieve the same and on other machinery to achieve rotation. All these applications can be for personal, commercial or leisure or recreational use

(11) 2/2025;

(24) 20.02.2025

(51) Int. CL. B2ID 26/14

(54) Valve Flapping Wing.



(75) Clement Sililo, House No. 03/31 John Laing

(57) This invention relates to a device that converts magnetic force into mechanical energy. it operates on the basis of using a mechanically controlled pieces of metal to implement a controlled oscillatory interaction between the magnetic poles of the rigid member with the magnetic poles of the rotor shaft. The result of this interaction is a mechanical energy which can be used for a wide range applications as an alternative source of energy.

**STATUTORY NOTICES UNDER THE TRADE MARKS ACT (CAP. 401)**

**APPLICATIONS FOR REGISTRATION OF TRADE MARKS LODGED DURING FEBRUARY 2025(AA)**

THESE APPLICATIONS are neither open to public inspection nor to opposition under section 23 of the Trade Marks Act until they are advertised as accepted under that section.

(210) 2050/2024; (220) 16.10.2024.

(511) Int. Cl.3.

(540) **AABEDA BLACK HENNA LABEL**

(750) Henna Industries PVT LTD, of Plot No. 45 Sector 27A Faridabad Haryana 121003, India.

(740) Geko Investments Limited, of P.O Box 31063, Lusaka.

---

(210) 280/2025; (220) 13.02.2025.

(511) Int. Cl.33.

(540) **LIQUOR SHOP SHOPRITE (and logo)**

(750) Shoprite International Limited, of Level 3, Alexander House, 35 Cybercity,, Ebene 72201, Mauritius.

(740) Christopher, Russell Cook & Co., of The Office @ 4658/A, Chikwa Road, Opposite Old Magistrates Court, P.O. BOX 34091, Lusaka.

---

(210) 281/2025; (220) 13.02.2025.

(511) Int. Cl.12.

(540) **AMS (and logo)**

(750) Africa Mobility Solutions, of 57-59 rue Yves Kermen, 92100 Boulogne-Billancourt, France.

(740) Christopher, Russell Cook & Co., of The Office @ 4658/A, Chikwa Road, Opposite Old Magistrates Court, P.O. BOX 34091, Lusaka.

---

(210) 282/2025; (220) 13.02.2025.

(511) Int. Cl.1.

(540) **UNIQ (and logo)**

(750) Axis House Group (Pty) Ltd., of The Boardwalk, Corner Victoria Avenue and Oxford Street, Hout Bay, Western Cape, 7806, South Africa.

(740) Christopher, Russell Cook & Co., of The Office @ 4658/A, Chikwa Road, Opposite Old Magistrates Court, P.O. BOX 34091, Lusaka.

---

(210) 284/2025; (220) 14.02.2025.

(511) Int. Cl.12.

(540) **Ti3 (and logo)**

(750) BYD COMPANY LIMITED, of No.1 Yan'an Road, Kuichong Street, Dapeng New District Shenzhen, Peoples Republic of China.

(740) Dench Intellectual Property Consultants, C/O Dench I.P Consultants No.59/4 East Road Chudleigh P/Bag E891, P.O Box 5, Lusaka.

---

(210) 285/2025; (220) 14.02.2025.

(511) Int. Cl.6.

(540) **BSL INFRASTRUCTURE (and logo)**

(750) BSL Infrastructure Limited, of Level 1, Palm Gr Ove House, Wickham's Cay 1, Road Town Tortola, Virgin Islands.

(740) TMB Advocates, The United Church of Zambia House, Ground Floor, Northern Wing, Plot No 8, Mosi O Tunya Road, Lusaka, P.O Box 51023, Lusaka.

---

(210) 286/2025; (220) 14.02.2025.

(511) Int. Cl.16.

(540) **BSL INFRASTRUCTURE (and logo)**

(750) BSL Infrastructure Limited, of Level 1, Palm Gr Ove House, Wickham's Cay 1, Road Town Tortola, Virgin Islands.

(740) TMB Advocates, The United Church of Zambia House, Ground Floor, Northern Wing, Plot No 8, Mosi O Tunya Road, Lusaka, P.O Box 51023, Lusaka.

---

(210) 287/2025; (220) 14.02.2025.

(511) Int. Cl.16.

(540) **gl africaenergy (and logo)**

(750) Gl Africa Energy Limited 10 Norwich Street, of 10 Norwich Street,, London, Ec4a Lbd, United Kingdom

(740) TMB Advocates, The United Church of Zambia House, Ground Floor, Northern Wing, Plot No 8, Mosi O Tunya Road, Lusaka, P.O Box 51023, Lusaka.

---

(210) 288/2025; (220) 14.02.2025.

(511) Int. Cl.16.

(540) **GL (and logo)**

(750) Gl Africa Energy Limited 10 Norwich Street, of 10 Norwich Street,, London, Ec4a Lbd, United Kingdom.

(740) TMB Advocates, The United Church of Zambia House, Ground Floor, Northern Wing, Plot No 8, Mosi O Tunya Road, Lusaka, P.O Box 51023, Lusaka.

---

(210) 289/2025; (220) 14.02.2025.

(511) Int. Cl.16.

(540) **NDOLA ENERGY COMPANY (and logo)**

(750) GI Africa Energy Limited 10 Norwich Street, of 10 Norwich Street,, London, Ec4a Lbd, United Kingdom.

(740) TMB Advocates, The United Church of Zambia House, Ground Floor, Northern Wing, Plot No 8, Mosi O Tunya Road, Lusaka, P.O Box 51023, Lusaka.

---

(210) 290/2025; (220) 14.02.2024.

(511) Int. Cl.25.

(540) **MARSHA (and logo)**

(740) Machelyn Muchende,of Ibex Twin Palm road, Lusaka, Zambia.

---

(210) 291/2025; (220) 14.02.2025.

(511) Int. Cl.28.

(540) **MARSHA (and logo)**

(750) Machelyn Muchende,of Ibex Twin Palm road, Lusaka, Zambia.

---

(210) 292/2025; (220) 14.02.2025.

(511) Int. Cl.33.

(540) **JAGUAR AND LABEL (and logo)**

(750) Sai Krishna Industry Zambia Limited, of Lusaka, Zambia.

---

(210) 293/2025; (220) 14.02.2025.

(511) Int. Cl.9.

(540) **FARMX (and logo)**

(750) Adam Gordon-Strong, of Farm no. 3575, Mwomboshi Area, Chisamba, Zambia.

(740) Christopher, Russell Cook & Co., of The Office @ 4658/A, Chikwa Road, Opposite Old Magistrates Court, P.O Box 34091, Lusaka.

---

(210) 294/2025; (220) 14.02.2025.

(511) Int. Cl.16.

(540) **FARMX (and logo)**

(750) Adam Gordon-Strong, of Farm no. 3575, Mwomboshi Area, Chisamba, Zambia.

(740) Christopher, Russell Cook & Co., of The Office @ 4658/A, Chikwa Road, Opposite Old Magistrates Court, P.O Box 34091, Lusaka.

---

(210) 295/2025; (220) 14.02.2025.

(511) Int. Cl.29.

(540) **LUCKY STAR NEW PERI-PERI (Pilchards) label (colour) (and logo)**

(750) Lucky Star Limited, of 9th Floor Oceana House, 25 Jan Smuts Street, Foreshore, 8001, Western Cape, South Africa.

(740) Christopher, Russell Cook & Co., of The Office @ 4658/A, Chikwa Road, Opposite Old Magistrates Court, P.O Box 34091, Lusaka.

---

(210) 296/2025; (220) 14.02.2025.

(511) Int. Cl.29.

(540) **LUCKY STAR (and logo)**

(750) Lucky Star Limited, of 9th Floor Oceana House, 25 Jan Smuts Street, Foreshore, 8001, Western Cape, South Africa.

(740) Christopher, Russell Cook & Co., of The Office @ 4658/A, Chikwa Road, Opposite Old Magistrates Court, P.O Box 34091, Lusaka.

---

(210) 297/2025; (220) 14.02.2025.

(511) Int. Cl.1.

(540) **THEOLAB (and logo)**

(750) Theolab Suppliers Limited of 1108, Mitengo, Ndola, Zambia.

---

(210) 298/2025; (220) 14.02.2025.

(511) Int. Cl.16.

(540) **DEMWIT (and logo)**

(750) Innocent Mubita, of Plot No. Kapwepwe Road, Avondale, Lusaka, Zambia.

---

(210) 299/2025; (220) 17.02.2025.

(511) Int. Cl.9.



(540) **HUPENYU LODGE**

(750) Taita Outlook (Private) Limited, of 233 Leopold Takawira Avenue, Suburbs, Bulawayo, Zimbabwe.

(740) Christopher, Russell Cook & Co., of The Office @ 4658/A, Chikwa Road, Opposite Old Magistrates Court, P.O. Box 34091, Lusaka.

---

(210) 300/2025; (220) 18.02.2025.

(511) Int. Cl.30.

(540) **AMAI'S PIES (and logo)**

(750) Bakerserve Zambia Limited, of Plot No. 7-11, off Kafue Road, Lusaka, Zambia.

---

(210) 301/2025; (220) 18.02.2025.

(511) Int. Cl.30.

(540) **AMAI'S PIES (and logo)**

(750) Bakerserve Zambia Limited, of Plot No. 7-11, off Kafue Road, Lusaka, Zambia.

---

(210) 302/2025; (220) 18.02.2025.

(511) Int. Cl.3.

(540) **LATTAFI**

(750) Lattafa Perfumes IND. LLC, of Industrial Area 11, P.O. Box 69793, Sharjah, United Arab of Emirates.

(740) Glow Up Enterprises Limited of Plot No. 6998, Kamwala, Lusaka

---

(210) 303/2025; (220) 18.02.2025.

(511) Int. Cl.5.

(540) **HOT DROPS & LABEL (and logo)**

(750) Trade Kings Limited, of Plot No. 29381, Nampundwe Road, Light Industrial Area, P.O. Box 30824, Lusaka, Zambia.

---

(210) 304/2025; (220) 18.02.2025.

(511) Int. Cl.5.

(540) **HOT DROPS & LABEL (and logo)**

(750) Trade Kings Limited, of Plot No. 29381, Nampundwe Road, Light Industrial Area, P.O. Box 30824, Lusaka, Zambia.

---

(210) 305/2025; (220) 18.02.2025.

(511) Int. Cl.12.

(540) **ACOYA**

(750) Nissan Jidosha Kabushiki Kaisha (also trading as Nissan Motor Co., Ltd), of No. 2 Takara-cho, Kanagawa-ku, Yokohama-shi, Kanagawa-ken, Japan.

(740) Fisher Cormack & Botha of P.O. Box 33890, Lusaka.

---

(210) 306/2025; (220) 18.02.2025.

(511) Int. Cl.30.

(540) **EVERMORE FOOD & BEVERAGE (and logo)**

(750) Evermore Food and Beverages Limited,of 50 Mbingu Wamutharika, Emmasdale, Lusaka, Zambia.

---

(210) 307/2025; (220) 18.02.2025.

(511) Int. Cl.16.

(540) **EVERMORE FOOD & BEVERAGE (and logo)**

(750) Evermore Food and Beverages Limited,of 50 Mbingu Wamutharika, Emmasdale, Lusaka, Zambia.

---

(210) 308/2025; (220) 18.02.2025.

(511) Int. Cl.30.

(540) **EVERMORE FOOD & BEVERAGE (and logo)**

(750) Evermore Food and Beverages Limited,of 50 Mbingu Wamutharika, Emmasdale, Lusaka, Zambia.

---

(210) 309/2025; (220) 18.02.2025.

(511) Int. Cl.16.

(540) **JACKPOT CRUNCH (and logo)**

(750) Evermore Food and Beverages Limited,of 50 Mbingu Wamutharika, Emmasdale, Lusaka, Zambia.

---

(210) 310/2025; (220) 18.02.2025.

(511) Int. Cl.30.

(540) **JACKPOT CRUNCH (and logo)**

(750) Evermore Food and Beverages Limited,of 50 Mbingu Wamutharika, Emmasdale, Lusaka, Zambia.

---

(210) 311/2025; (220) 18.02.2025.

(511) Int. Cl.25.

(540) **JACKPOT CRUNCH (and logo)**

(750) Evermore Food and Beverages Limited,of 50 Mbingu Wamutharika, Emmasdale, Lusaka, Zambia.

---

(210) 312/2025; (220) 18.02.2025.

(511) Int. Cl.24.

(540) **RHINO SHIELD PEST SOLUTIONS (and logo)**

(750) Rhino ZamAgro Limited, of Stand B1, Opposite Main Arena, Showgrounds, Lusaka, Zambia.

---

(210) 313/2025; (220) 19.02.2025

(511) Int. Cl.16.

(540) **"CHARLES-LEAF COLLECTION DESIGNS" (and logo)**

(750) Angenat Supplies And Company Limited, of Plot No. 483, Gardenia Road, Avondale, Lusaka, Zambia.

---

(210) 314/2025; (220) 19.02.2025

(511) Int. Cl.25.

(540) **"CHARLES-LEAF COLLECTION DESIGNS" (and logo)**

(750) Angenat Supplies And Company Limited, of Plot No. 483, Gardenia Road, Avondale, Lusaka, Zambia.

---

(210) 315/2025; (220) 19.02.2025

(511) Int. Cl.7.

(540) **eDON (and logo)**

(750) Zhejiang Yidun Mechanical & Electrical Co., Ltd., of No.10, 5th Street, Eastern New District, Wenling, Zhejiang Province., Peoples Republic of China.

(740) Eric Silwamba, Jalasi & Linyama Legal Practitioners, Plot No. 12 at William Burton Place Chilekwa Mwamba Road off Lubu/Saise Roads, Longacres, Post Net Box 571 P/Bag E891, Lusaka.

---

(210) 316/2025; (220) 19.02.2025

(511) Int. Cl.7.

(540) **eDON PROMAX (and logo)**

(750) Zhejiang Yidun Mechanical & Electrical Co., Ltd., of No.10, 5th Street, Eastern New District, Wenling, Zhejiang Province., Peoples Republic of China.

(740) Eric Silwamba, Jalasi & Linyama Legal Practitioners, Plot No. 12 at William Burton Place Chilekwa Mwamba Road off Lubu/Saise Roads, Longacres, Post Net Box 571 P/Bag E891, Lusaka.

---

(210) 317/2025; (220) 19.02.2025

(511) Int. Cl.9.

(540) **eDON (and logo)**

(750) Zhejiang Yidun Mechanical & Electrical Co., Ltd., of No.10, 5th Street, Eastern New District, Wenling, Zhejiang Province., Peoples Republic of China.

(740) Eric Silwamba, Jalasi & Linyama Legal Practitioners, Plot No. 12 at William Burton Place Chilekwa Mwamba Road off Lubu/Saise Roads, Longacres, Post Net Box 571 P/Bag E891, Lusaka.

---

(210) 318/2025; (220) 19.02.2025

(511) Int. Cl.9.

(540) **EDONPROMAX (and logo)**

(750) Zhejiang Yidun Mechanical & Electrical Co., Ltd., of No.10, 5th Street, Eastern New District, Wenling, Zhejiang Province., Peoples Republic of China.

(740) Eric Silwamba, Jalasi & Linyama Legal Practitioners, Plot No. 12 at William Burton Place Chilekwa Mwamba Road off Lubu/Saise Roads, Longacres, Post Net Box 571 P/Bag E891, Lusaka.

---

(210) 319/2025; (220) 19.02.2025

(511) Int. Cl.32.

(540) **MIWK (and logo)**

(750) Californian Beverages Limited, of Plot No. 1644 Malambo Road, P.O Box 32095, Lusaka, Zambia.

---

(210) 320/2025; (220) 19.02.2025.

(511) Int. Cl.32.

(540) **ORESA (and logo)**

(750) Californian Beverages Limited, of Plot No. 1644 Malambo Road, P.O Box 32095, Lusaka, Zambia.

---

(210) 321/2025; (220) 19.02.2025

(511) Int. Cl.9.

(540) **EMPILO (and logo)**

(750) The University of The Witwatersrand, of 1 Jan Smuts Avenue, Braamfontein, Johannesburg, South Africa.

(740) Christopher, Russell Cook & Co., of The Office @ 4658/A, Chikwa Road, Opposite Old Magistrates Court, P.O Box 34091, Lusaka.

---

(210) 322/2025; (220) 19.02.2025

(511) Int. Cl.16.

(540) **EMPILO (and logo)**

(750) The University of The Witwatersrand, of 1 Jan Smuts Avenue, Braamfontein, Johannesburg, South Africa.

(740) Christopher, Russell Cook & Co., of The Office @ 4658/A, Chikwa Road, Opposite Old Magistrates Court, P.O Box 34091, Lusaka.

---

(210) 323/2025; (220) 19.02.2025

(511) Int. Cl.20.

(540) **SLEEPMASTERS (and logo)**

(750) PEPKOR Trading Proprietary Limited, of 36 Stellenberg Road, Parow Industria, Western Cape, South Africa.

(740) Christopher, Russell Cook & Co., of The Office @ 4658/A, Chikwa Road, Opposite Old Magistrates Court, P.O Box 34091, Lusaka.

---

(210) 324/2025; (220) 19.02.2025

(511) Int. Cl.24.

(540) **SLEEPMASTERS (and logo)**

(750) PEPKOR Trading Proprietary Limited, of 36 Stellenberg Road, Parow Industria, Western Cape, South Africa.

(740) Christopher, Russell Cook & Co., of The Office @ 4658/A, Chikwa Road, Opposite Old Magistrates Court, P.O Box 34091, Lusaka.

---

(210) 325/2025; (220) 19.02.2025

(511) Int. Cl.3.

(540) **KARITE (and logo)**

(750) Shantou Yingji Cosmetics Co., Ltd., of Jiajin Building, Liannan, Xiashan Street, Chaonan, Shantou Guangdong, Peoples Republic of China.

(740) Dench Intellectual Property Consultants, C/O Dench I.P Consultants, No.59/4, East Road, Chudleigh, P/Bag E891, P.O Box 5, Lusaka.

---

(210) 326/2025; (220) 20.02.2025.

(511) Int. Cl.3.

(540) **KISS BEAUTY (and logo)**

(750) Shantou Yingji Cosmetics Co., Ltd., of Jiajin Building, Liannan, Xiashan Street, Chaonan, Shantou Guangdong, Peoples Republic of China.

(740) Dench Intellectual Property Consultants, C/O Dench I.P Consultants, No.59/4, East Road, Chudleigh, P/Bag E891, P.O Box 5, Lusaka.

---

(210) 327/2025; (220) 20.02.2025.

(511) Int. Cl.9.

(540) **MAYiKO GROUP OF COMPANIES (and logo)**

(750) Mayiko Infrastructure Limited, of Plot 21 Stand No. 1418, Los Angeles Boulevard, Longacres, Lusaka, Lusaka Province, Zambia.

(740) Nsapato & Co. Advocates, Sub C of Lot 1835/M, 3rd Street, Ibex Hill, Lusaka.

---

(210) 328/2025; (220) 20.02.2025.

(511) Int. Cl.12.

(540) **MAYIKO GROUP OF COMPANIES (and logo)**

(750) Mayiko Infrastructure Limited, of Plot 21 Stand No. 1418, Los Angeles Boulevard, Longacres, Lusaka, Lusaka Province, Zambia.

(740) Nsapato & Co. Advocates, Sub C of Lot 1835/M, 3rd Street, Ibex Hill, Lusaka.

---

(210) 329/2025; (220) 20.02.2025.

(511) Int. Cl.32.

(540) **YI FEI YE (and logo)**

(750) Cheng Jun Xi Ying Investment Limited, of Plot No. 9, 7th Street, Nkana West, Kitwe, Zambia.

---

(210) 330/2025; (220) 20.02.2025.

(511) Int. Cl.16.

(540) **BIG BOSS (and logo)**

(750) Aaksha Distributors Limited, of Plot No. 91, Town Industrial road, second class, Luanshya, Zambia.

---

(210) 331/2025; (220) 20.02.2025.

(511) Int. Cl.16.

(540) **JUMPEES (and logo)**

(750) Aaksha Distributors Limited, of Plot No. 91, Town Industrial road, second class, Luanshya, Zambia.

---

(210) 332/2025; (220) 20.02.2025.

(511) Int. Cl.34.

(540) **FURONGWANG (and logo)**

(750) Avenir Tobbacco Investments Limited, of Plot No. 7254 Off Los Angeles Road, Longacres, Lusaka, Zambia.

---

(210) 333/2025; (220) 20.02.2025.

(511) Int. Cl.2.

(540) **SOGO PAINTS (and logo)**

(750) Silvertex Enteprise Limited, of Plot 36087 Mumbwa Road, Chinika Industrial Area, Lusaka, Lusaka, Zambia.

---

(210) 334/2025; (220) 20.02.2025.

(511) Int. Cl.12.

(540) **JAMBO PLASTICS (and logo)**

(750) Silvertex Enterprise Limited, of Plot 36087 Mumbwa Road, Chinika Industrial Area, Lusaka, Zambia.

---

(210) 335/2025; (220) 20.02.2025. .

(511) Int. Cl.12.

(540) **SOGO PLASTIC (and logo)**

(750) Silvertex Enterprise Limited, of Plot 36087 Mumbwa Road, Chinika Industrial Area, Lusaka, Zambia

---

(210) 336/2025; (220) 24.02.2025.

(511) Int. Cl.34.

(540) **BLACK DIAMOND (and logo)**

(750) KT & G CORPORATION, of 71, Beotkkot-gil, Daedeok-gu, Daejeon, Republic of Korea.

(740) Dench Intellectual Property Consultants, C/O Dench I.P Consultants, No.59/4, East Road, Chudleigh, P/Bag E891, P.O Box 5, Lusaka.

---

(210) 337/2025; (220) 24.02.2025.

(511) Int. Cl.32.

(540) **BLUE ROCK**

(750) Bigtree Beverages Limited, of Plot No. 33607, Mumbwa Road, Light Industrial Area, P.O. Box 30824, Lusaka, Zambia.

---

(210) 338/2025; (220) 24.02.2025.

(511) Int. Cl.29.

(540) **BALAJI WAFERS (and logo)**

(750) Balaji Wafers private Limited, of Survey No. 19, Vajdi (Vad), Kalawad Road, Ta, Lodhika, Rajkot- 360021, Gujarat, India.

(740) Christopher, Russell Cook & Co., of The Office @ 4658/A, Chikwa Road, Opposite Old Magistrates Court, P.O Box 34091, Lusaka.

---

(210) 339/2025; (220) 24.02.2025.

(511) Int. Cl.30.

(540) **BALAJI WAFERS (and logo)**

(750) Balaji Wafers private Limited, of Survey No. 19, Vajdi (Vad), Kalawad Road, Ta, Lodhika, Rajkot- 360021, Gujarat, India.

(740) Christopher, Russell Cook & Co., of The Office @ 4658/A, Chikwa Road, Opposite Old Magistrates Court, P.O Box 34091, Lusaka.

---

(210) 340/2025; (220) 24.02.2025.

(511) Int. Cl.5.

(540) **V DEVICE (and logo)**

(750) BAE Industry Limited, of Plot No. 273, Thorite Road, Garneton, Kitwe, Zambia.

---

(210) 341/2025; (220) 24.02.2025.

(511) Int. Cl.4.

(540) **SIMEL & DEVICE (and logo)**

(750) Senyanmei Oils Zambia Limited, of Plot No. 9 Central Street Nkana West Kitwe, Zambia..

---

(210) 342/2025; (220) 24.02.2025.

(511) Int. Cl.7.

(540) **Fenn-Mat- Conveyor belting Premium Quality-MEL (and logo)**

(750) Matecs Enterprises Limited, of Plot 1332 Kanongesha Road, Heavy Industrial Area, Kitwe, Zambia.

---

(210) 343/2025; (220) 25.02.2025.

(511) Int. Cl.3.

(540) **NYOMI**

(750) Solpia Group Incorporated, of C/O M/S Worldwide Formations, P.O Box 33964, Dubai, United Arab of Emirates.

(740) Galloway & Co., Plot No. 11 Chabisa Road, Woodlands, Lusaka.

---

(210) 344/2025; (220) 25.02.2025.

(511) Int. Cl.26.

(540) **NYOMI**

(750) Solpia Group Incorporated, of C/O M/S Worldwide Formations, P.O Box 33964, Dubai, United Arab of Emirates.

(740) Galloway & Co., Plot No. 11 Chabisa Road, Woodlands, Lusaka.

---

(210) 345/2025; (220) 25.02.2025.



(511) Int. Cl.16.

(540) **ISAR ENERGY (and logo)**

(750) Isar Energy Limited, of Plot No. 13 Nwezi Road, Roma Township, Lusaka, Zambia.

---

(210) 346/2025; (220) 25.02.2025.

(511) Int. Cl.29.

(540) **ZAMBEZI TASTY SELECTION (and logo)**

(750) Skaps Limited, of Plot No. 6 Chibote Avenue, Parklands, Kitwe, Zambia.

---

(210) 347/2025; (220) 25.02.2025.

(511) Int. Cl.5.

(540) **MOONLITE (and logo)**

(750) Nedypronas Trading Limited, of Plot No. 20839, Chinika Industrial Area, Engen Filing Station Premises, Along Mumbwa Road, Lusaka, Zambia.

---

(210) 348/2025; (220) 25.02.2025.

(511) Int. Cl.9.

(540) **TOURVEST (and logo)**

(750) Tourvest Holdings (Pty) Limited, of Stonewedge Office Park, 1 Wedgewood Link Road, Bryanston, 2021, South Africa.

(740) Christopher, Russell Cook & Co., of The Office @ 4658/A, Chikwa Road, Opposite Old Magistrates Court, P.O Box 34091, Lusaka.

---

(210) 349/2025; (220) 25.02.2025.

(511) Int. Cl.16.

(540) **TOURVEST (and logo)**

(750) Tourvest Holdings (Pty) Limited, of Stonewedge Office Park, 1 Wedgewood Link Road, Bryanston, 2021, South Africa.

(740) Christopher, Russell Cook & Co., of The Office @ 4658/A, Chikwa Road, Opposite Old Magistrates Court, P.O Box 34091, Lusaka.

---

(210) 350/2025; (220) 25.02.2025.

(511) Int. Cl.9.

(540) **DON'T STOP**

(750) SanDisk Corporation, of 951 SanDisk Drive, Milpitas, California 95035, United States of America.

(740) Christopher, Russell Cook & Co., of The Office @ 4658/A, Chikwa Road, Opposite Old Magistrates Court, P.O Box 34091, Lusaka.

---

(210) 351/2025; (220) 25.02.2025.

(511) Int. Cl.16.

(540) **DON'T STOP**

(750) SanDisk Corporation, of 951 SanDisk Drive, Milpitas, California 95035, United States of America.

(740) Christopher, Russell Cook & Co., of The Office @ 4658/A, Chikwa Road, Opposite Old Magistrates Court, P.O Box 34091, Lusaka.

---

(210) 352/2025; (220) 25.02.2025.

(511) Int. Cl.31.

(540) **TAKII**

(750) Takii & Co., LTD, of 180, Minamiebisu-cho, Inokuma-higashiiru, Umekoji-dori, Shimogyo-ku, Kyoto-shi, Kyoto 600-8686, Japan.

(740) Christopher, Russell Cook & Co., of The Office @ 4658/A, Chikwa Road, Opposite Old Magistrates Court, P.O Box 34091, Lusaka.

---

(210) 353/2025; (220) 25.02.2025.

(511) Int. Cl.31.

(540) **TAKII (and logo)**

(750) Takii & Co., LTD, of 180, Minamiebisu-cho, Inokuma-higashiiru, Umekoji-dori, Shimogyo-ku, Kyoto-shi, Kyoto 600-8686, Japan.

(740) Christopher, Russell Cook & Co., of The Office @ 4658/A, Chikwa Road, Opposite Old Magistrates Court, P.O Box 34091, Lusaka.

---

(210) 354/2025; (220) 26.02.2025.

(511) Int. Cl.16.

(540) **Her Roots**

(750) Ruth Chitunda, of 6056 Sibweni Road, Northmead Lusaka, Zambia.

---

(210) 355/2025; (220) 26.02.2025.

(511) Int. Cl.16.

(540) **Her Rootz**

(750) Ruth Chitunda, of 6056 Sibweni Road, Northmead Lusaka, Zambia.

---

(210) 356/2025; (220) 26.02.2025.

(511) Int. Cl.30.

(540) **Kitchen King (and logo)**

(750) Pacific Ventures Limited, of Plot No. L/7050/M1, Chinika Light Industrial Area, Mumbwa Road, Near Konzani Garden, Lusaka, Zambia.

---

(210) 357/2025; (220) 26.02.2025.

(511) Int. Cl.30.

(540) **Meal Maker (and logo)**

(750) Pacific Ventures Limited, of Plot No. L/7050/M1, Chinika Light Industrial Area, Mumbwa Road, Near Konzani Garden, Lusaka, Zambia.

---

(210) 358/2025; (220) 26.02.2025.

(511) Int. Cl.32.

(540) **GOFIT (and logo)**

(750) Bigtree Beverages Limited, of Plot No. 33607, Mumbwa Road, P. O. Box 30824, Lusaka, Zambia.

---

(210) 359/2025; (220) 26.02.2025.

(511) Int. Cl.7.

(540) **TESLA (and logo)**

(750) Internet Group d.o.o Beograd, of Savski nasip 7, 11070 Beograd, Serbia.

(740) Nsapato & Co. Advocates of Sub C of Lot 1835/M, 3rd Street, Ibex Hill, , Lusaka.

---

(210) 360/2025; (220) 26.02.2025.

(511) Int. Cl.9.

(540) **TESLA (and logo)**

(750) Internet Group d.o.o Beograd, of Savski nasip 7, 11070 Beograd, Serbia.

(740) Nsapato & Co. Advocates of Sub C of Lot 1835/M, 3rd Street, Ibex Hill, , Lusaka.

---

(210) 361/2025; (220) 26.02.2025.

(511) Int. Cl.11.

(540) **TESLA (and logo)**

(750) Internet Group d.o.o Beograd, of Savski nasip 7, 11070 Beograd, Serbia.

(740) Nsapato & Co. Advocates of Sub C of Lot 1835/M, 3rd Street, Ibex Hill, , Lusaka.

---

(210) 362/2025; (220) 26.02.2025.

(511) Int. Cl.26.

(540) **Jessie's (and logo)**

(750) Meili Hair Investments Limited, of F2344/B/6/ WW Chipwenu Pwenu Road Makeni East, Zambia.

---

(210) 363/2025; (220) 26.02.2025.

(511) Int. Cl.32.

(540) **Clear+ (and logo)**

(750) Aone Beverages Limited, of Plot #10 off Lufubu Road, Kalundu, Lusaka, Zambia.

---

(210) 364/2025; (220) 26.02.2025.

(511) Int. Cl.34.

(540) **Dahongying (and logo)**

(750) China Tobacco Zhejiang Industrial Co., Ltd, of No. 77 Zhongshan Nan Road, Hangzhou City, Zhejiang Province, Peoples Republic of China.

(740) Eric Silwamba, Jalasi & Linyama Legal Practitioners, 12 Chilekwa Mwamba Road, Off Lubu/Saise Roads, Longacres, Lusaka.

---

(210) 365/2025; (220) 26.02.2025.

(511) Int. Cl.34.

(540) **Device Mark (and logo)**

(750) China Tobacco Zhejiang Industrial Co., Ltd, of No. 77 Zhongshan Nan Road, Hangzhou City, Zhejiang Province, Peoples Republic of China.

(740) Eric Silwamba, Jalasi & Linyama Legal Practitioners, 12 Chilekwa Mwamba Road, Off Lubu/Saise Roads, Longacres, Lusaka.

---

(210) 366/2025; (220) 26.02.2025.

(511) Int. Cl.34.

(540) **Great Eagle (and logo)**

(750) China Tobacco Zhejiang Industrial Co., Ltd, of No. 77 Zhongshan Nan Road, Hangzhou City, Zhejiang Province, Peoples Republic of China.

(740) Eric Silwamba, Jalasi & Linyama Legal Practitioners, 12 Chilekwa Mwamba Road, Off Lubu/Saise Roads, Longacres, Lusaka.

---

(210) 367/2025; (220) 26.02.2025.

(511) Int. Cl.34.

(540) **Great Eagle (and logo)**

(750) China Tobacco Zhejiang Industrial Co., Ltd, of No. 77 Zhongshan Nan Road, Hangzhou City, Zhejiang Province, Peoples Republic of China.

(740) Eric Silwamba, Jalasi & Linyama Legal Practitioners, 12 Chilekwa Mwamba Road, Off Lubu/Saise Roads, Longacres, Lusaka.

---

(210) 368/2025; (220) 26.02.2025.

(511) Int. Cl.34.

(540) **Device Mark (and logo)**

(750) China Tobacco Zhejiang Industrial Co., Ltd, of No. 77 Zhongshan Nan Road, Hangzhou City, Zhejiang Province, Peoples Republic of China.

(740) Eric Silwamba, Jalasi & Linyama Legal Practitioners, 12 Chilekwa Mwamba Road, Off Lubu/Saise Roads, Longacres, Lusaka.

---

(210) 373/2025; (220) 27.02.2025.

(511) Int. Cl.34.

(540) **Device Mark (and logo)**

(750) Tropikal Brands Africa Limited, of Kasarani Mwiki Road, P. O Box 49465 001000, Nairobi, Kenya.

(740) Rosemary Chuulu Matimba, Plot No. 17 Sunflower Street, Salama Street, Lusaka.

---

(210) 376/2025; (220) 28.02.2025.

(511) Int. Cl.5.

(540) **NIP NAP LABEL (and logo)**

(750) Fairy Investments Limited, of Plot #21G Chipwenupwenu Road, Makeni, P.O Box 37995, Lusaka, Zambia.

---

(210) 377/2025; (220) 28.02.2025.

(511) Int. Cl.16.

(540) **NIP NAP LABEL (and logo)**

(750) Fairy Investments Limited, of Plot #21G Chipwenupwenu Road, Makeni, P.O Box 37995, Lusaka, Zambia.

---

(210) 384/2025; (220) 04.03.2025.

(511) Int. Cl.32.

(540) **SOFTDRIP AQUA (and logo)**

(750) Mahammedy Asin Habib Vali and Fazila Yunus, of, Zambia.

---

(210) 385/2025; (220) 04.03.2025.

(511) Int. Cl.30.

(540) **ARHAN FREEZITS (and logo)**

(750) Arhan Investments Limited, of F/687/1/A Off Pelica Road, Makeni, Lusaka, Zambia.

---

(210) 386/2025; (220) 04.03.2025.

(511) Int. Cl.16.

(540) **CASH CONVERTERS (and logo)**

(750) Cash Converters Pty Ltd, of Level 18, Chancery House, 37 St. George Terrace, Perth, Western Australia, Australia.

(740) Christopher, Russell Cook & Co., of The Office @ 4658/A, Chikwa Road, Opposite Old Magistrates Court, P.O Box 34091, Lusaka.

---

(210) 387/2025; (220) 04.03.2025.

(511) Int. Cl.29.

(540) **VIVA MEALS (and logo)**

(750) Cash Converters Pty Ltd, of Level 18, Chancery House, 37 St. George Terrace, Perth, Western Australia, Australia.

(740) Christopher, Russell Cook & Co., of The Office @ 4658/A, Chikwa Road, Opposite Old Magistrates Court, P.O Box 34091, Lusaka.

---

(210) 388/2025; (220) 04.03.2025.

(511) Int. Cl.25.

(540) **JAS (and logo)**

(750) Jas Garments Limited, of Shop No. A2, First Floor, AL Complex Cha Cha Cha, Lusaka, Zambia

---



**STATUTORY NOTICES UNDER THE TRADE MARKS ACT (CAP. 401)**

**ACCEPTED APPLICATIONS FOR REGISTRATION OF TRADE MARKS - ABSOLUTE. (BB/CA)**

NOTICE IS HEREBY GIVEN, that any person who has ground of opposition to registration of the following trademarks may, within two months of the date of publication hereof, file a notice of opposition on Form T.M. No. 6 with the Registrar of Trade Marks, Zambia Patent Office.

Preferably, any objector must file the notice of opposition only after writing the applicant to give him reasonable notice about the intended opposition in order to afford him an opportunity of withdrawing his application. Failure to do this will be taken into account in considering any application by any party for an order for costs if the opposition is uncontested by the applicant. A letter B, C, or D prefixed to the application number means that the application is for registration, respectively, in Part B, C (certification mark) or D(defensive mark) of the register of trade marks. If an application proceeds in Part A, the application number is unaccompanied by any letter.

- (210) 183/2024; (220)29.01.2024  
(731)(750)H and H Commodities Limited of Plot No. 2049 Dallas, Kabwe, Zambia  
(511) Int.Cl.12  
(510) Parts of vehicles, for example, bumpers, window screens, steering wheels  
(540) **H&H TRUCKING**
- 

- (210) 1598/2024; (220)14.08.2024  
(731)(750)Toki Ventures Limited of 10 Nalikwanda Road, Woodlands, Lusaka, Zambia  
(511) Int.Cl.16  
(510) Paper and cardboard; printed matter; bookbinding material; photographs; stationery and office requisites, except furniture; adhesives for stationery or household purposes; artists' and drawing materials; paintbrushes; instructional and teaching materials; plastic sheets, films and bags for wrapping and packaging; printers' type, printing blocks .  
(540)



- 
- (210) 1779/2024; (220)05.09.2024  
(731)(750)Glenmark Specialty SA of  
Place du Port 2, CH-2000 Neuchatel, Switzerland, Zambia  
(740) Dench Intellectual Property Consultants, No 59/4, Great East Road, Chudleigh, P/Bag E891, P.O Box 5,  
Lusaka,  
(511) Int.Cl.5  
(510) Pharmaceutical preparations for treatment of cancer  
(540)



- 
- (210) 1881/2024; (220) 24.09.2024  
(731)(750)Parrogate Gineries Limited of Plot No. 397/D Makeni,, Lusaka, Zambia  
(511) Int.Cl.3  
(510) Lotions, cosmetics, perfumes, soaps, perfumery, essential oils, hair lotions and dentifrices, Bleaching preparations and other substances for laundry use.



(540) **GRACE**

---

(210) 2025/2024; (220) 10.10.2024

(731)(750)Fohow International (Zambia) Limited of Plot No. 18246 Off Njanji Road, Libala South, Lusaka, Zambia

(511) Int.Cl.16

(510) stamps [seals] , stamp pads , printed matter , document files [stationery] , document holders [stationery], office requisites, except furniture., banners of paper, bookbinding apparatus and machines [office equipment], bookbinding material, booklets, books, calendars, cards\* / charts, catalogues, carrier bags of paper or plastic shopping bags of paper or plastic, copying paper [stationery], engravings, embroidery designs [patterns], stationery, flyers, graphic prints, note books,newsletters, paper\* , writing materials

(540)



---

(210) 2113/2024; (220) 23.10.2024

(731)(750)Blooming Harmony PTE. LTD of 10 Anson Road No. II-20 International Plaza, Singapore

(740) Dench Intellectual Property Consultants, No 59/4, Great East Road, Chudleigh, P/Bag E891, P.O Box 5, Lusaka

(511) Int.Cl.11

(510) Showers; water-pipes for sanitary installations; water closets; water filtering apparatus; faucets for pipes and pipelines; flushing tanks; water purification installations; kettles, electric; Refrigerators; hair driers."

(540)

*Perfina*

---

(210) 2114/2024; (220) 23.10.2024

(731)(750)Blooming Harmony PTE. LTD of 10 Anson Road No. II-20 International Plaza, Singapore

(740) Dench Intellectual Property Consultants, No 59/4, Great East Road, Chudleigh, P/Bag E891, P.O Box 5, Lusaka.

(511) Int.Cl.21

(510) Utensils for household purposes; Cups; Dishes; table plates; bowls [basins]; coffee services [tableware]; porcelain ware; china ornaments; Vases; pet feeding bowls."

(540)

*Perfina*

---

(210) 2115/2024; (220)

(731)(750)Glenmark Pharmaceuticals Limited of B/2 Mahalaxmi Chamber 22 Bhulabhai Desai Road, Mumbai 400026, India

(740) Dench Intellectual Property Consultants C/o Dench I.P Consultants, No.55/4, East Road, Chudleigh, P/Bag E891, P.O Box 5, Lusaka

(511) Int.Cl.5

(510) "Pharmaceutical & medical preparations for the treatment of cancer".

(540) **Glenza**

---

(210) 2116/2024; (220) 23.10.2024

(310)

(731)Glenmark Pharmaceuticals Limited of B/2 Mahalaxmi Chamber 22 Bhulabhai Desai Road, Mumbai 400026, India

(740)Dench Intellectual Property Consultants, C/o Dench I.P Consultants, No.55/4, East Road, Chudleigh, P/Bag E891, P.O Box 5, Lusaka

(511) Int.Cl.5

(510) "Pharmaceutical & medical preparations for the treatment of cancer".

(540) **Zenalutix**

---

(210) 2128/2024; (220) 30.10.2024

(731)(750)ASB Investments Limited of Plot no. 26571/917, Lenu Road, Kamwala South, Lusaka, Zambia

(511) Int.Cl.3

(510) Hair preparations and treatments; hair care preparations, hair serum, hair oil; hair shampoos and conditioners; skin hair removal and shaving preparations; cleansers; skin conditioners; face wash, perfume, deodorant; toiletries; soaps; cosmetics, hair relaxers, hair mouse, hair spray, hair gel, hair nourishers, hair balms, hair lotions, hair colourants, hair bleach, . hair dyes. cream, moisturizer and make-up cream, serum for cosmetic purpose, face wash, shampoo; perfume, deodorant; talcum powder; soaps; hand wash; dentifrices; essential oils

(540) **SPACELIFE**

---

(210) 2225/2024; (220) 05.11.2024

(731)(750)Snow PTE. Ltd of 15A Tuas avenue 18, # 03-01, Jiang Huang Business Centre, Singapore

(740) Dench Intellectual Property Consultants No. 59/4, East Road, Chudleigh, P/Bag E891, P.O Box 5, Lusaka

(511) Int.Cl.6

(510) pipes of metal; pipe fittings of metal; water-pipes o~ gutter pipes of metal; building materials of metal; roofing of metal, incorporating photovoltaic cells; pantiles of metal; frames of metal for building; screws of metal; fittings of metal for windows; elbows of metal for pipes; junctions of metal for pipes; pipe couplings of metal; valves of metal, other than parts of machines; reinforcing materials of metal for pipes; washers of metal; branching pipes of metal; drain traps [valves] of metal; fittings of metal for furniture , "

(540) **SNOW**

---

(210) 2226/2024; (220) 05.11.2024

(731)(750)Snow PTE. Ltd of 15A Tuas avenue 18, # 03-01, Jiang Huang Business Centre, Singapore

(740) Dench Intellectual Property Consultants No. 59/4, East Road, Chudleigh, P/Bag E891, P.O Box 5 , , Lusaka

(511) Int.Cl.11

(510) Taps; taps for pipes and pipelines; mixer taps for water pipes; heating installations; heaters for baths; water-pipes for sanitary installations; bath installations; watering installations, automatic; sanitary apparatus and installations; wash-hand basins [parts of sanitary installations]; water purification installations; water flushing installations; showers; solar thermal collectors [heating]

(540) **SNOW**

---

(210) 2227/2024; (220) 05.11.2024

(731)(750)Snow PTE. Ltd of 15A Tuas avenue 18, # 03-01, Jiang Huang Business Centre, Singapore

(740) Dench Intellectual Property Consultants, No. 59/4, East Road, Chudleigh, P/Bag E891, P.O Box 5, Lusaka

(511) Int.Cl.17

(510) "Pipe muffs, not of metal; pipe gaskets; plastic substances, semi-processed; reinforcing materials, not of metal, for pipes; junctions, not of metal, for pipes; fittings, not of metal, for flexible pipes; fittings, not of metal, for rigid pipes; flexible hoses, not of metal; insulating materials; waterproof packings; padding materials of rubber or plastics; water tight rings; waterproof sealants; duct tapes; plastic film, other than for wrapping, gaskets, caulking materials; chemical compositions for sealing leaks; waterproof membranes made of polymers

(540) **SNOW**

---

(210) 2228/2024; (220) 05.11.2024

(731)(750)Snow PTE. Ltd of 15A Tuas avenue 18, # 03-01, Jiang Huang Business Centre, Singapore

(740) Dench Intellectual Property Consultants No. 59/4, East Road, Chudleigh, P/Bag E891, P.O Box 5, Lusaka

(511) Int.Cl.19

(510) Cements; bitumen; tiles, not of metal; water pipes, not of metal; gutter pipes, not of metal; doors, not of metal; windows, not of metal; non-metal ceiling panels; slabs, not of metal, for building; building materials, not of metal; roofing, not of metal, incorporating photovoltaic cells; roof coverings, not of metal; garden sheds of non-metallic materials polymeric bitumen emulsion for waterproofing buildings; coatings [building materials] waterproof membranes made of bitumen; bituminous products for building; rigid pipes not of metal, for building ."

(540) **SNOW**

---

(210) 2230/2024; (220) 05.11.2024

(731)(750)Snow PTE. Ltd of 15A Tuas avenue 18, # 03-01, Jiang Huang Business Centre, Singapore

(740) Dench Intellectual Property Consultants, No. 59/4, East Road, Chudleigh, P/Bag E891, P.O Box 5, Lusaka

(511) Int.Cl.6

(510) pipes of metal; pipe fittings of metal; water-pipes o~ gutter pipes of metal; building materials of metal; roofing of metal, incorporating photovoltaic cells; pantiles of metal; frames of metal for building; screws of metal; fittings of metal for windows; elbows of metal for pipes; junctions of metal for pipes; pipe couplings of metal; valves of metal, other than parts of machines; reinforcing materials of metal for pipes; washers of metal; branching pipes of metal; drain traps [valves] of metal; fittings of metal for furniture ,"

(540)



---

(210) 2231/2024; (220) 05.11.2024

(731)(750)Snow PTE. Ltd of 15A Tuas avenue 18, # 03-01, Jiang Huang Business Centre, Singapore

(740) Dench Intellectual Property Consultants, No. 59/4, East Road, Chudleigh, P/Bag E891, P.O Box 5, Lusaka

(511) Int.Cl.11

(510) Taps; taps for pipes and pipelines; mixer taps for water pipes; heating installations; heaters for baths; water-pipes for sanitary installations; bath installations; watering installations, automatic; sanitary apparatus and installations; wash-hand basins [parts of sanitary installations]; water purification installations; water flushing installations; showers; solar thermal collectors [heating]

(540)



---

(210) 2232/2024; (220)

(731)(750)Snow PTE. Ltd of 15A Tuas avenue 18, # 03-01, Jiang Huang Business Centre, Singapore

(740) Dench Intellectual Property Consultants, C/O Dench I.P Consultants, No.55, Off B.Y Road, Chudleigh, P/Bag E891, P.O Box 5, Lusaka

(511) Int.Cl.17

(510) "Pipe muffs, not of metal; pipe gaskets; plastic substances, semi-processed; reinforcing materials, not of metal, for pipes; junctions, not of metal, for pipes; fittings, not of metal, for flexible pipes; fittings, not of metal, for rigid pipes; flexible hoses, not of metal; insulating materials; waterproof packings; padding materials of rubber or plastics; water tight rings; waterproof sealants; duct tapes; plastic film, other than for wrapping, gaskets, caulking materials; chemical compositions for sealing leaks; waterproof membranes made of polymers

(540)



---

(210) 2233/2024; (220) 05.11.2024

(731)(750)Snow Pte. Limited of 15A Tuas Avenue 18, #03-01 Jian Huang Business Centre, Singapore

(740) Dench Intellectual Property Consultants, C/O Dench I.P Consultants, No.55, Off B.Y Road, Chudleigh, P/Bag E891, P.O Box 5, Lusaka

(511) Int.Cl.19

(510) Cements; bitumen; tiles, not of metal; water pipes, not of metal; gutter pipes, not of metal; doors, not of metal; windows, not of metal; non-metal ceiling panels; slabs, not of metal, for building; building materials, not of metal; roofing, not of metal, incorporating photovoltaic cells; roof coverings, not of metal; garden sheds of non-metallic materials polymeric bitumen emulsion for waterproofing buildings; coatings [building materials] waterproof membranes made of bitumen; bituminous products for building; rigid pipes not of metal, for building ."

(540)



---

(210) 2351/2024; (220)

(731)(750)Zhang Shian of Plot No. 8856, Alick Nkhata Road, Longacres, Lusaka, Zambia

(511) Int.Cl.9

(510) Scientific, nautical, surveying, photographic, cinematographic, optical, weighing, measuring, signalling, checking (supervision), life-saving and teaching apparatus and instruments; apparatus and instruments for conducting, switching, transforming, accumulating, regulating or controlling electricity; apparatus for recording, transmission or reproduction of sound or images; magnetic data carriers, recording discs; automatic vending machines and mechanisms for coin-operated apparatus; cash registers, calculating machines, data processing equipment and computers; fire-extinguishing apparatus

(540)

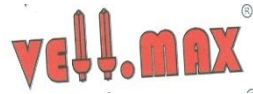

---

(210) 2364/2024; (220) 25.11.2024

(731)(750)HFC Prestige International Operations Switzerland Sàrl of Chemin Louis-Hubert 1-3 CH-1213 Petit-Lancy, Switzerland

(740) Dench Intellectual Property Consultants, No. 59/4, East Road, Chudleigh, P/Bag E891, P.O Box 5, Lusaka

(511) Int.Cl.3

(510) Nail polish remover; Nail polish; Nail polish base coat.

(540)



---

(210) 2366/2024; (220) 28.11.2024

(731)(750)Take Plus Investments limited of Plot No. 202/A, Sunrise Farm, Mumbwa Road, Lusaka West, Lusaka, Zambia

(511) Int.Cl.6

(510) Bolts, Screws, Sails, and Window Fasteners.

(540) **MAAT**

---

(210) 2485/2024; (220) 12.12.2024

(731)(750)Pacific Ventures Limited of Plot No. L/7050/M/1, Chinika Light Industrial Area, Mumbwa Road, Near Konzani Garden, Lusaka, Zambia

(511) Int.Cl.30.

(510) Soya chucks and other preparations made from cereals

(540) **BIG BULL**

---

(210) 2550/2024; (220) 16.12.2024

(731)(750)Jetlak Foods Limited of Factory Access Road, Off Kiambu Road, Ruiru, P.O. Box 461-00232, Nairobi, Kenya

(740) B & M Legal Practitioners, 3rd Floor, Evexia Commercial Building, Plot No. 1014, Church Road,

(511) Int.Cl.29

(510) meat, fish, poultry and game; meat extracts; preserved, frozen, dried and cooked fruits and vegetables; jellies, jams, compotes; eggs; milk and milk products; eligible oils and fats

(540)



(210) 2622/2024; (220) 27.12.2024

(731)(750)Guo Kaimin of 506 Daguolou Village, Chengjiao Township, Yucheng County, Shangqui City, Henan Province, Peoples Republic of China

(511) Int.Cl.7

(510) Hand-held tools, other than hand-operated; Saws [machines]; Electric hammers; Cutting machines; Electric hand drills; Spray guns for paint; Dynamos; Machines and apparatus for polishing [electric]; Pumps [machines]; chain saws; knives, electric; grinding machines; Electric welding apparatus; Machines and apparatus for cleaning, electric; Lawnmowers [machines]; screwdrivers, electric; drilling machines; grindstones [parts of machines]; drilling heads [parts of machines]; nail extractors, electric

(540)



(210) 2623/2024; (220) 30.12.2024

(731)(750)Guo Kaimin of 506 Daguolou Village, Chengjiao Township, Yucheng County, Shangqui City, Henan Province, Peoples Republic of China

(511) Int.Cl.8

(510) Pliers; Spanners [hand tools]; Saws [hand tools]; Hammers [hand tools]; Scissors; Garden tools, hand-operated; Bits [hand tools]; Cutting tools [hand tools]; screwdrivers, non-electric; Augers [hand tools]; Hobby knives [scalpels]; Wire strippers [hand tools]; lifting jacks, hand-operated; Riveters [hand tools]; Ratchets [hand tools]; Trowels; Grindstones [hand tools]; Abrading instruments [hand instruments]; spades [hand tools]; Chisels

(540)

**FONITOR**

---

(210) 16/2025; (220) 06.01.2025

(731)(750)Enrich Strandz Services of A 1139-MC Northgate Gardens, Off Kasangula Road, Lusaka, Zambia

(511) Int.Cl.16

(510) Printed matter, bookbinding material, photographs, address stamps, postage stamps, printed coupons; printed publications, printing sets, printers' type, prints and printing blocks.

(540)



---

(210) 17/2025; (220) 06.01.2025

(731)(750)Enrich Strandz Services of A 1139-MC Northgate Gardens, Off Kasangula Road, Lusaka, Zambia

(511) Int.Cl.16

(510) Printed matter, bookbinding material, photographs, address stamps, postage stamps, printed coupons; printed publications, printing sets, printers' type, prints and printing blocks.

(540)



---

(210) 18/2025; (220) 06.01.2025

(731)(750)Enrich Strandz Services of A 1139-MC Northgate Gardens, Off Kasangula Road, Lusaka, Zambia

(511) Int.Cl.16

(510) Printed matter, bookbinding material, photographs, address stamps, postage stamps, printed coupons; printed publications, printing sets, printers' type, prints and printing blocks

(540)



---

(210) 19/2025; (220) 06.01.2025

(731)(750)Enrich Strandz Services of A 1139-MC Northgate Gardens, Off Kasangula Road, Lusaka, Zambia

(511) Int.Cl.16

(510) Printed matter, bookbinding material, photographs, address stamps, postage stamps, printed coupons; printed publications, printing sets, printers' type, prints and printing blocks

(540)

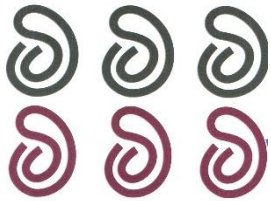

(210) 20/2025;

(220) 06.01.2025

(731)(750)Enrich Strandz Services of A 1139-MC Northgate Gardens, Off Kasangula Road, Lusaka, Zambia

(511) Int.Cl.16

(510) Printed matter, bookbinding material, photographs, address stamps, postage stamps, printed coupons; printed publications, printing sets, printers' type, prints and printing blocks.

(540)

**Strandz Strandz**

**Strandz Strandz**

**Strandz**

**Strandz**

(210) 35/2025;

(220) 08.01.2025

(731)(750)Brohks Aneta Pharmaceuticals Limited of Plot No. 1695, Corner of Kalambo and Lumumba Road, CBD, Lusaka, Zambia

(511) Int.Cl.5

(510) Pharmaceuticals, medical and veterinary preparations, sanitary preparations for medical purposes

(540)



(210) 36/2025;

(220) 08.01.2025

(731)(750)Brohks Aneta Pharmaceuticals Limited of Plot No. 1695, Corner of Kalambo and Lumumba Road, CBD, Lusaka, Zambia

(511) Int.Cl.10

(510) Condoms

(540)



(210) 58/2025;

(220) 14.01.2025

(731)(750)MK Petroleum Company Limited of 397A Makeni Road, Makeni, Lusaka, Zambia

(740) Kenite Corporate Consultancy and Advisory, Plot No. 4, Libala, Lusaka.

(511) Int.Cl.16

(510) printed matter, printed publications, prints [engravings], engravings, engraving plates embroidery designs [patterns], files [office requisites], flyers, graphic prints, seals [stamps] stamps [seals], writing materials



(540)



---

(210) 62/2025;

(220) 16.01.2025

(731)(750)eCITY Energy Limited of Stand No. 22768, Thabo Mbeki Road, Building 3, Acacia Park, Lusaka, Zambia

(511) Int.Cl.16

(510) Paper and cardboard; printed matter; bookbinding material; photographs; stationery and office requisites, except furniture; adhesives for stationery or household purposes; artists' and drawing materials; paintbrushes; instructional and teaching materials; plastic sheets, films and bags for wrapping and packaging; printers' type, printing blocks

(540)



**eCity Charging**

---

(210) 63/2025;

(220) 16.01.2025

(731)(750)Crowdstage Industry Limited of F/690/A21/P6, Ferngrove Farm, Lusaka West, Kasupe, Zambia

(511) Int.Cl.16

(510) Paper and cardboard; printed matter; bookbinding material; photographs; stationery and office requisites, except furniture; adhesives for stationery or household purposes; artists' and drawing materials; paintbrushes; instructional and teaching materials; plastic sheets, films and bags for wrapping and packaging; printers' type, printing blocks

(540) **LBB FACTORY OUTLET**

---

(210) 64/2025;

(220) 16.01.2025

(731)(750)Crowdstage Industry Limited of F/690/A21/P6, Ferngrove Farm, Lusaka West, Kasupe, Zambia

(511) Int.Cl.25

(510) Clothing, footwear and headgear

(540) **LBB FACTORY OUTLET**

---

(210) 65/2025;

(220) 16.01.2025

(731)(750)Crowdstage Industry Limited of F/690/A21/P6, Ferngrove Farm, Lusaka West, Kasupe, Zambia

(511) Int.Cl.16

(510) Paper and cardboard; printed matter; bookbinding material; photographs; stationery and office requisites, except furniture; adhesives for stationery or household purposes; artists' and drawing materials; paintbrushes; instructional and teaching materials; plastic sheets, films and bags for wrapping and packaging; printers' type, printing blocks

(540) **LBB FACTORY STORE**

---

(210) 66/2025; (220) 16.01.2025  
(731)(750)Crowdstage Industry Limited of F/690/A21/P6, Ferngrove Farm, Lusaka West, Kasupe, Zambia  
(511) Int.Cl.25  
(510) Clothing, footwear, headgear  
(540) **LBB FACTORY STORE**

---

(210) 80/2025; (220) 17.01.2025  
(731)(750)Brandbrew S.A. of 15, Breedewues, 1259 Senningerberg, Luxembourg  
(740) CORPUS LEGAL PRACTITIONERS, Piziya Office Park Stand No. 2374,Thabo Mbeki Road, P.O. Box 32115, ,  
Lusaka, Zambia  
(511) Int.Cl.33  
(510) Malt-based alcoholic beverages; spirit-based alcoholic beverages; alcoholic ciders, alcoholic seltzers.  
(540)

## **MIKE'S**

---

(210) 85/2025; (220) 20.01.2025  
(731)(750)Akanda Investments Limited of Plot No. 12593, Off Mumbwa Road, Chinika Industrial Area, P.o Box 32190,  
Lusaka, Zambia  
(511) Int.Cl.32  
(510) Non- alcoholic drinks included in this class  
(540) **YOFRUT**

---

(210) 96/2025; (220) 21.01.2025  
(731)(750)Crowdstage Industry Limited of F/690/A21/P6, Ferngrove Farm, Lusaka West, Kasupe, Zambia  
(511) Int.Cl.6  
(510) Common metals and their alloys; ores; metal materials for building and construction; transportable buildings of  
metal; non- electric cables and wires of common metal; small items of metal hardware; metal containers for  
storage or transport; safes  
(540)



---

(210) 97/2025; (220) 21.01.2025  
(731)(750)Crowdstage Industry Limited of F/690/A21/P6, Ferngrove Farm, Lusaka West, Kasupe, Zambia

(511) Int.Cl.14

(510) Precious metals and their alloys; jewellery, precious and semi- precious stones; horological and chronometric instruments

(540)



---

(210) 98/2025;

(220) 21.01.2025

(731)(750)Crowdstage Industry Limited of F/690/A21/P6, Ferngrove Farm, Lusaka West, Kasupe, Zambia

(511) Int.Cl.24

(510) Textiles and substitutes for textiles; household linen; curtains of textile or plastic

(540)



---

(210) 99/2025;

(220) 21.01.2025

(731)(750)Crowdstage Industry Limited of F/690/A21/P6, Ferngrove Farm, Lusaka West, Kasupe, Zambia

(511) Int.Cl.33

(510) Alcoholic beverages, except beers; alcoholic preparations for making beverages

(540)



---

(210) 100/2025;

(220) 21.01.2025

(731)(750)Crowdstage Industry Limited of F/690/A21/P6, Ferngrove Farm, Lusaka West, Kasupe, Zambia

(511) Int.Cl.25

(510) Clothing, footwear and headgear

(540)



---

(210) 101/2025;

(220) 21.01.2025

(731)(750)Crowdstage Industry Limited of F/690/A21/P6, Ferngrove Farm, Lusaka West, Kasupe, Zambia

(511) Int.Cl.11

(510) Apparatus and installations for lighting, heating, cooling, steam generating, cooking, drying, ventilating, water supply and sanitary purposes

(540)



---

(210) 102/2025; (220) 21.01.2025

(731)(750)Crowdstage Industry Limited of F/690/A21/P6, Ferngrove Farm, Lusaka West, Kasupe, Zambia

(511) Int.Cl.14

(510) Precious metals and their alloys; jewellery, precious and semi-precious stones; horological and chronometric instruments

(540)



---

(210) 103/2025; (220) 21.01.2025

(731)(750)Crowdstage Industry Limited of F/690/A21/P6, Ferngrove Farm, Lusaka West, Kasupe, Zambia

(511) Int.Cl.8

(510) Hand tools and implements, hand operated; cutlery; side arms, except firearms; razors

(540)



---

(210) 104/2025; (220) 21.01.2025

(731)(750)Crowdstage Industry Limited of F/690/A21/P6, Ferngrove Farm, Lusaka West, Kasupe, Zambia

(511) Int.Cl.16

(510) Paper and cardboard; printed matter; bookbinding material; photographs; stationery and office requisites, except furniture; adhesives for stationery or household purposes; drawing materials and materials for artists; paintbrushes; instructional and teaching materials; plastic sheets, films and bags for wrapping and packaging; printers' type, printing blocks.

(540)



---

(210) 105/2025; (220) 21.01.2025

(731)(750)Crowdstage Industry Limited of F/690/A21/P6, Ferngrove Farm, Lusaka West, Kasupe, Zambia

(511) Int.Cl.21.

(510) Household or kitchen utensils and containers; cookware and tableware, except forks, knives and spoons; brushes except paint brushes; brush- making materials; articles for cleaning purposes; unworked or semi-worked glass, except building glass; glassware; porcelain and earthenware

(540)



---

(210) 106/2025; (220) 21.01.2025

(731)(750)Crowdstage Industry Limited of F/690/A21/P6, Ferngrove Farm, Lusaka West, Kasupe, Zambia

(511) Int.Cl.20.

(510) Furniture, mirrors, picture frames; containers, not of metal, for storage or transport; unworked born, horn, whalebone or mother-of-pearl; shells; meerschaum; yellow amber

(540)



---

(210) 107/2025; (220) 21.01.2025

(731)(750)Crowdstage Industry Limited of F/690/A21/P6, Ferngrove Farm, Lusaka West, Kasupe, Zambia

(511) Int.Cl.18

(510) Leather and imitations of leather; animal skins and hides; luggage and carrying bags; umbrellas and parasols; walking sticks; whips, harness and saddlery; collars, leashes and clothing for animals

(540)



---

(210) 108/2025; (220) 21.01.2025

(731)(750)Crowdstage Industry Limited of F/690/A21/P6, Ferngrove Farm, Lusaka West, Kasupe, Zambia

(511) Int.Cl.32

(510) Beers; non- alcoholic beverages; mineral and aerated waters; fruit beverages and fruit juices; syrups and other preparations for making non- alcoholic beverages

(540)



---

(210) 109/2025; (220) 21.01.2025

(731)(750)Crowdstage Industry Limited of F/690/A21/P6, Ferngrove Farm, Lusaka West, Kasupe, Zambia

(511) Int.Cl.26

(510) Lace, braid and embroidery and haberdashery ribbons and bows; buttons; hooks and eyes, pins and needles; artificial flowers; hair decorations; false hair

(540)



---

(210) 110/2025; (220) 21.01.2025

(731)(750)Crowdstage Industry Limited of F/690/A21/P6, Ferngrove Farm, Lusaka West, Kasupe, Zambia

(511) Int.Cl.34

(510) Tobacco and tobacco substitutes; cigarettes and cigars; electronic cigarettes and oral vaporizers for smokers; smokers' articles; matches.

(540)



---

(210) 114/2025; (220) 21.01.2025

(731)(750)Lusaka Agro Vet Limited of Plot 803 Lumumba Road, Opposite City Market, Lusaka, Zambia

(511) Int.Cl.16

(510) Paper and cardboard; printed matter; bookbinding material; photographs; stationery and office requisites, except furniture; adhesives for stationery or household purposes; drawing materials and materials for artists

(540)



---

(210) 138/2025; (220) 24.01.2025

(731)(750)Mutupa Wildlife Trails limited, Kenny Kapata, Hope Mwiche Chibamba, Wana Kapata, Mapalo Kapata of Plot No. 15432/M Lilayi Road, Lilayi Lusaka, Zambia

(740) Novan Kasana M21, Chilonga Close, Chelstone, Lusaka

(511) Int.Cl.16

(510) Catalogues; Manual (Handbooks), Handbooks (Manual)

(540)



---

(210) 160/2025; (220) 27.01.2025

(731)(750)Flave Restaurant Limited of Flave Restaurant Limited, Plot No. 3715, Kwacha Road, Olympia, Lusaka, Zambia  
(511) Int.Cl.29  
(510) Meat, fish, poultry and game; meat extracts; preserved, frozen, dried and cooked fruits and vegetables; jellies, jams, compotes; eggs; milk, cheese, butter, yogurt and other milk products; oils and fats for food  
(540)



---

(210) 161/2025; (220) 29.01.2025  
(731)(750)Flave Restaurant Limited of Flave Restaurant Limited, Plot No. 3715, Kwacha Road, Olympia, Lusaka, Zambia  
(511) Int.Cl.30  
(510) Confectionary, candies, coffee, tea, cocoa and artificial coffee; rice, pasta and noodles; cereal bars, maize flakes, corn flakes, tapioca and sago; flour and preparations made from cereals; bread, pastries; chocolate; ice cream, sugar, honey, treacle; yeast, baking powder; salt, seasonings, spices, vinegar, sauces.  
(540)



---

(210) 209/2025; (220) 29.01.2025  
(731)(750)Zhejiang Sunpro Power Technology Co., Ltd of Science and Technology Industry Cluster, Qinggang, Yuhuan, Zhejiang, China, Peoples Republic of China  
(740) Eric Silwamba, Jalasi & Linyama Legal Practitioners, Plot No. 12 at William Burton Place Chilekwa Mwamba Road off Lubu/Saise Roads, Longacres, Post Net Box 571 P/Bag E891, Lusaka  
(511) Int.Cl.9  
(510) Junction box (electricity); wire, inverter (electricity); electricity device for rectification; electrolysis device; charging station for electric vehicles; battery, photovoltaic cell; solar cell; solar panel for power generation; electronic interactive whiteboard; smart glasses (data processing) flash signal lamp; electronic monitoring device; detector; alarm  
(540)



---

(210) 233/2025; (220) 29.01.2025  
(731)(750)Gatoma Investments Limited of Plot No 203/B Great East Road, Hillview, Chipata Eastern Province, Zambia  
(740) Helen Banda & Associates Lega Practitioners  
(511) Int.Cl.12  
(510) Motorcycle, motorcycle engines, motorcycle frames.

(540)



---

(210) 234/2025; (220) 29.01.2025

(731)(750)Cutwater Spirits, LLC of 9750 Distribution Avenue, San Diego, CA 92121, United States of America.

(740) Corpus Legal Practitioners, Piziya Office Park, Stand No. 2374, Thabo Mbeki Road, P.O. Box 32115, Lusaka

(511) Int.Cl.33

(510) Alcoholic beverages (except beers); alcoholic cocktail mixes.

(540)

## CUTWATER

---

(210) 254/2025; (220) 06.02.2025

(731)(750)G&W Distilling Inc. of #8-7167 Vantage Way, Delta, British Columbia V4g1k7, Canada

(740) Corpus Legal Practitioners, Piziya Office Park, Stand No. 2374 Thabo Mbeki Road P.O.Box 32115, Lusaka

(511) Int.Cl.33

(510) Alcoholic beverages namely aperitifs, alcoholic bitters, alcoholic cocktails, alcoholic coolers, alcoholic fruit cocktail drinks, alcoholic fruit drinks, alcoholic punch, bitters, gin, vodka, whiskey, wine, wine-based drinks

(540)

## NÜTRL

---

(210) 261/2025; (220) 07.02.2025

(731)(750)Beeline Telecoms Limited of Suit No.1, Unit 2 Counting Square, Thabo Mbeki Road, Lusaka, Zambia

(511) Int.Cl.9

(510) Scientific, research, navigation, surveying, photographic, cinematographic, audiovisual, optical, weighing, measuring, signalling, detecting, testing, inspecting, life-saving and teaching apparatus and instruments; apparatus and instruments for conducting, switching, transforming, accumulating, regulating or controlling the distribution or use of electricity; apparatus and instruments for recording, transmitting, reproducing or processing sound, images or data; recorded and downloadable media, computer software, blank digital or analogue recording and storage media; mechanisms for coin-operated apparatus; cash registers, calculating devices; computers and computer peripheral devices; diving suits, divers' masks, ear plugs for divers, nose clips for divers and swimmers, gloves for divers, breathing apparatus for underwater swimming; fire-extinguishing apparatus

(540)



---

(210) 262/2025; (220) 07.02.2025

(731)(750)Beeline Telecoms Limited of Suit No.1, Unit 2 Counting Square, Thabo Mbeki Road, Lusaka, Zambia

(511) Int.Cl.9



(510) Scientific, research, navigation, surveying, photographic, cinematographic, audiovisual, optical, weighing, measuring, signalling, detecting, testing, inspecting, life-saving and teaching apparatus and instruments; apparatus and instruments for conducting, switching, transforming, accumulating, regulating or controlling the distribution or use of electricity; apparatus and instruments for recording, transmitting, reproducing or processing sound, images or data; recorded and downloadable media, computer software, blank digital or analogue recording and storage media; mechanisms for coin-operated apparatus; cash registers, calculating devices; computers and computer peripheral devices; diving suits, divers' masks, ear plugs for divers, nose clips for divers and swimmers, gloves for divers, breathing apparatus for underwater swimming; fire-extinguishing apparatus

(540)

*JOIN THE MOVEMENT*

---

(210) 278/2025; (220) 12.02.2025

(731)(750)Shangri-la Inn of Plot 19 Kalemba Drive, Parklands, Kitwe, Copperbelt Province, Zambia

(740) Nsapato & Co. Advocates, Sub C of Lot 1835/M, 3rd Street, Ibex Hill, Lusaka

(511) Int.Cl.16

(510) Paper and cardboard; printed matter; bookbinding material; photographs; stationery and office requisites, except furniture; adhesives for stationery or household purposes; artists' and drawing materials; paintbrushes; instructional and teaching materials; plastic sheets, films and bags for wrapping and packaging; printers' type, printing blocks.

(540)



---

(210) 279/2025; (220) 12.02.2025

(731)(750)Shangri-la Inn of Plot 19 Kalemba Drive, Parklands, Kitwe, Copperbelt Province, Zambia

(740) Nsapato & Co. Advocates Sub C of Lot 1835/M, 3rd Street, Ibex Hill, Lusaka

(511) Int.Cl.25

(510) Clothing, footwear, headgear.

(540)



---

(210) 292/2025; (220) 14.02.2025

(731)(750)Sai Krishna Industry Zambia Limited of Lusaka, Zambia

(511) Int.Cl.33

(510) Vodka and alcohol in class 33

(540)



---

(210) 302/2025; (220) 18.02.2025

(731)(750) Lattafa Perfumes Ind. Llc of Industrial Area 11, P.O. Box 69793, Sharjah, U.Arab Emirates

(740) Glow Up Enterprises Limited, Plot No. 6998, Kamwala, Lusaka.

(511) Int.Cl.3

(510) Perfumes

(540) **LATTAFA**

---

(210) 312/2025; (220) 18.02.2025

(731)(750) Rhino ZamAgro Limited of Stand B1, Opposite Main Arena, Showgrounds, Lusaka, Zambia

(511) Int.Cl.24

(510) Household Linen, Bedspreads, Pillow shams, Towels of Texile, Bed Linen of paper, Sleeping bags, Sleeping bag liners and Mosquito Nets.

(540)



---

(210) 335/2025; (220) 20.02.2025

(731)(750) Silvertex Enteprise Limited of Plot 36087 Mumbwa Road, Chinika Industrial Area, Lusaka, Zambia

(511) Int.Cl.12

(510) Rubber material for recapping tyres; - floating anti-pollution barriers; - adhesive tapes, other than stationery and not for medical or household purposes; plastic films, other than for wrapping and packaging, for example, anti-dazzle films for windows; - elastic threads and threads of rubber or plastic, not for textile use; - certain goods made of the materials in this class not otherwise classified by function or purpose, for example, foam supports for flower arrangements, padding and stuffing materials of rubber or plastics, rubber stoppers, shock-absorbing buffers of rubber, rubber bags or envelopes for packaging

(540)



- (210) 2412/2024; (220) 04.12.2024  
(731) Mayiko Infrastructure Limited, Plot No. 1418, Los Angeles Boulevard, Lond Acres, Lusaka, Zambia  
(740) Nsapato & Co. Advocates, Lot 1835/M , 3<sup>rd</sup> Street, Ibex Hill, Lusaka, Zambia  
(511) Int.Cl.25  
(510) Clothing, footwear, headgear.



(540)

---

- (210) 2413/2024; (220) 04.12.2024  
(731) Mayiko Infrastructure Limited, Plot No. 1418, Los Angeles Boulevard, Lond Acres, Lusaka, Zambia  
(740) Nsapato & Co. Advocates, Lot 1835/M , 3<sup>rd</sup> Street, Ibex Hill, Lusaka, Zambia  
(511) Int.Cl.19  
(510) Building materials (non-metallic); non-metallic rigid pipes for building; asphalt, pitch and bitumen; non-metallic transportable buildings; monuments, not of metal.



(540)

---

- (210) 1789/2022/; (220) 02.12.2022  
(731) UPL Mauritius Limited of 6th Floor, Suite 157B, Harbor Front Building, President John Kennedy Street, Port Louis, Mauritius.  
(740) Galloway & Co., of 11 Chabisa Road, Woodlands, Lusaka.  
(511) Int.Cl.1  
(510) Chemicals for use in industry, science, as well as in agriculture, horticulture and forestry; compost, manures, fertilizers; biological preparations for use in industry and science.

(540) **AGROMECTIN**

---

- (210) 2573/2024; (220) 19.12.2024

(731)(750) Bigtree Beverages Limited of Plot No. 33607, Mumbwa Road, Light Industrial Area, P.O. Box 30824, Lusaka.

(511) Int.Cl.32

(510) energy drinks, fruit juices, fruit beverages: mineral and aerated waters and other non-alcoholic beverages; fruit syrups and other preparations for making beverages; Beers

(540) **CHOWZA**

---

# STATUTORY NOTICES UNDER THE TRADE MARKS ACT (CAP. 401)

## ACCEPTED APPLICATIONS FOR REGISTRATION OF TRADE MARKS - CONDITIONAL. (BB/CA)

NOTICE IS HEREBY GIVEN, that any person who has ground of opposition to registration of the following trade marks may, within two months of the date of publication hereof, file a notice of opposition on Form T.M. No. 6 with the Registrar of Trade Marks, Zambia Patent Office.

Preferably, any objector must file the notice of opposition only after writing the applicant to give him reasonable notice about the intended opposition in order to afford him an opportunity of withdrawing his application. Failure to do this will be taken into account in considering any application by any party for an order for costs if the opposition is uncontested by the applicant. A letter B, C, or D prefixed to the application number means that the application is for registration, respectively, in Part B, C (certification mark) or D (defensive mark) of the register of trade marks. If an application proceeds in Part A, the application number is unaccompanied by any letter.

(210) 617/2024; (220) 09.04.2024

(731)(750)Matshidiso Portia Mngomezulu and Celimphilo Hlabeyakhe Sicelo Mngomezulu,  
No. 193 Sitstone Street, Stoneridge Country Estate, Monavoni, 0149, Centurion, South Africa.

(740)

(511) Int.Cl.3

(510) Non-medicated cosmetics and toiletry preparations; non-medicated dentifrices; perfumery, essential oils; bleaching preparations and other substances for laundry use; cleaning, polishing and abrasive preparations.

(526) Registration of this trade mark shall give no right to the exclusive use of the words "PURE LUXURY FOR YOUR SKIN" & the letter "M" except in the stylised manner as represented on the form



(540)

---

(210) 618/2024; (220) 09.04.2024

(731)(750)Matshidiso Portia Mngomezulu and Celimphilo Hlabeyakhe Sicelo Mngomezulu,  
No. 193 Sitstone Street, Stoneridge Country Estate, Monavoni, 0149, Centurion, South Africa.

(740)

(511) Int.Cl.3

(510) Non-medicated cosmetics and toiletry preparations; non-medicated dentifrices; perfumery, essential oils; bleaching preparations and other substances for laundry use; cleaning, polishing and abrasive preparations.

(540) **PORTIA M**

---

(210) 1686/2024; (220) 23.08.2024

(731) Chemi & Cotex Industries Limited, Plot No. 88/89, Mbezi Industrial Area, Dar Es Salaam, Tanzania.

(740) Dench Intellectual Property Consultants, No. 59/4, East Road, Chudleigh, P/Bag E891, P.O BOX 5, Lusaka.

(511) Int.Cl.3

- (510) Oral care products, toothpaste, dental gels, dentrfrices, mouthwashes; bleaching preparations, tooth polishing preparations, cosmetic tooth whitening preparations
- (526) The trade mark subsists in the word "Whitedent", while the rest of the wording is descriptive and therefore non-trade mark matter.



(540)

- (210) 1744/2024; (220) 29.08.2024
- (731)(750)CHEMI & COTEX INDUSTRIES LTD, New Bagamoyo Road, Plot No. 89/90, Mbezi Industrial Area, Dar es Salaam, Tanzania.
- (740) Dench Intellectual Property Consultants, No. 59/4,East Road, Chudleigh, P/Bag E891, P.O BOX 5, Lusaka
- (511) Int.Cl.3
- (510) Oral care products, toothpaste, dental gels, dentrfrices, mouthwashes; bleaching preparations, tooth polishing preparations, cosmetic tooth whitening preparations
- (526) The registration of this trade mark shall give no exclusive right to the use of the words 'fluoride toothpaste', separately apart from the mark as a whole

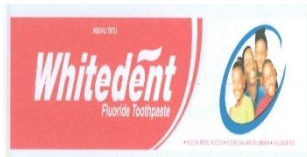

(540)

- (210) 1745/2024; (220) 29.08.2024
- (731)(750)CHEMI & COTEX INDUSTRIES LTD, New Bagamoyo Road, Plot No. 89/90, Mbezi Industrial Area, Dar es Salaam, Tanzania.
- (740) Dench Intellectual Property Consultants, No. 59/4,East Road, Chudleigh, P/Bag E891, P.O BOX 5, Lusaka
- (511) Int.Cl.3
- (510) Oral care products, toothpaste, dental gels, dentrfrices, mouthwashes; bleaching preparations, tooth polishing preparations, cosmetic tooth whitening preparations
- (526) The registration of this trade mark shall give no exclusive right to the use of the words 'fluoride toothpaste' or the word 'herbal', separately apart from the mark as a whole



(540)

---

(210) 2041/2024; (220) 15.10.2024

(731)(750)Parrogate Gineries Limited, Plot No 397/A/D, Makeni, Lusaka, Zambia.

(511) Int.Cl.30

(510) Sweets, candy, coffee, tea, cocoa and artificial coffee; rice; tapioca and sago; flour and preparations made from cereals; bread, pastries and confectionery; edible ices; sugar, honey, treacle; yeast, baking- powder; salt; mustard; vinegar, sauces (condiments); spices; ice.

(526) Proceeding in terms of Section 23(1): to be advertised before acceptance. Registration of this trade mark shall give no exclusive right to the use of the word 'Lollipop' each separately apart from the mark as a whole.

(540) **WHISTLE LOLLIPOP**

---

(210) 2093/2024; (220) 21.10.2024

(731)(750)Bruhati Industries Limited, Plot No. 874, Zambia road, Heavy Industrial Estate, Ndola, Zambia.

(511) Int.Cl.

(510)

(526) proceeding in terms of section 23

(540) **CLUB-7**

---

(210) 2145/2024; (220) 31.10.2024

(731)(750)Gourock Zambia Limited, Plot No. E12, Arusha Street, P.O Box 70467, Ndola, Zambia.

(511) Int.Cl.9

(510) (Electrodes), Scientific, nautical, surveying, photographic, cinematographic, optical, weighing, measuring, signaling, checking (supervision), life-saving and teaching apparatus and instruments; apparatus and instruments for conducting, switching, transforming, accumulating, regulating or controlling electricity; apparatus for recording, transmission or reproduction of sound or images; magnetic data carriers, recording discs; compact discs, DVDs and other digital recording media; mechanisms for coin-operated apparatus; cash registers, calculating machines, data processing equipment, computers; computer software; fire extinguishing apparatus.

(526) Registration of this trade mark shall give no exclusive right to the use of the word "Electrodes" each separately apart from the mark as a whole.



(540)

---

(210) 2352/2024; (220) 25.11.2024

(731)(750)Zhang Shian, Plot No. 8856, Alick Nkhata Road, Longacres, Lusaka, Zambia.

(511) Int.Cl.9

(510) Scientific, nautical, surveying, photographic, cinematographic, optical, weighing, measuring, signalling, checking (supervision), life-saving and teaching apparatus and instruments; apparatus and instruments for conducting, switching, transforming, accumulating, regulating or controlling electricity; apparatus for recording, transmission or reproduction of sound or images; magnetic data carriers, recording discs; automatic vending machines and mechanisms for coin-operated apparatus; cash registers, calculating machines, data processing equipment and computers; fire-extinguishing apparatus.

The logo consists of the letters 'AVC' in a bold, orange, sans-serif font. The letters are slightly shadowed, giving them a 3D appearance as if they are floating above a surface.

(540)

---

(210) 2363/2024; (220) 27.11.2024

(731) HFC Prestige International Operations Switzerland Sàrl, Chemin Louis-Hubert 1-3 CH-1213 Petit-Lancy, Switzerland.

(740) Dench Intellectual Property Consultants, No. 59/4, East Road, Chudleigh, P/Bag E891, P.O Box 5, Lusaka.

(511) Int.Cl.3

(510) "Perfumeries, essential oils, preparations for body and beauty care, hair lotions, dentifrices, soaps.

(540) **GABRIELA SABATINI**

---

(210) 2403/2024; (220) 03.12.2024

(731) Bravos Distilleries Limited, Plot No. 8, Manchinchi Road, Northmead, Lusaka Province,, Lusaka, Zambia.

(740) Kaysha Consultants Ltd, Plot No. 8 Manchichi Road, Northmead, Lusaka Province, ,

(511) Int.Cl.33

(510) Alcoholic beverages (Except beers)

(526) To be associated with trademark No. 705/2023



(540)



---

(210) 67/2025; (220) 16.01.2025

(731)(750)Lusaka Agro Vet Limited, Plot 803, Lumumba road, opposite City Market, Lusaka, Zambia.

(511) Int.Cl.16

(510) Paper and cardboard; printed matter; bookbinding material; photographs; stationery and office requisites, except furniture; adhesives for stationery or household purposes; drawing materials and materials for artists



(540)

---

(210) 83/2025; (220) 20.01.2025

(731)(750)Akanda Investments Limited, Plot No. 12593, Off Mumbwa Road, Chinika Industrial Area P.o Box 32190, Lusaka, Zambia.

(511) Int.Cl.32

(510) Non- alcoholic drinks included in this class

(540) **MILKATO**

---

(210) 115/2025; (220) 23.01.2025

(731)(750)Rose Green Lines farms Limited, Plot 722, New Avondale, Lusaka, Zambia.

(511) Int.Cl.31

(510) Various crops/vegetation, live animals, meal for animals, various fruits, etc.

(526) Registration of this trademark shall give no exclusive right to the use of the mark "Farms" except for the use of the mark as a whole



(540)

---

(210) 118/2025; (220) 23.01.2025

(731)(750)Hashmi Enterprises Limited, Plot 4449, Kamwala Chilumbulu Road, P.O Box 38895, Lusaka, Zambia.

(511) Int.Cl.16

(510) Ballpoint pens

(526) Proceeding in terms of Section 23 (1)



(540)

---

(210) 119/2025; (220) 23.01.2025

(731)(750)Hashmi Enterprises Limited, Plot 4449, Kamwala Chilumbulu Road, P.O Box 38895, Lusaka, Zambia.

(511) Int.Cl.30

(510) Rice, pasta and noodles; tapioca and sago; flour and preparations made from cereals; bread, pastries and confectionery; chocolate; ice cream, sorbets and other edible ices; sugar, honey, treacle; yeast, baking powder; salt, seasonings, spices, preserved herbs; vinegar, sauces and other condiments.

(526) Registration of this Trademark shall give no exclusive right to the words "Kitchen delight" exclusively except for the mark as a whole



(540)

---

(210) 121/2025; (220) 23.01.2025

(731)(750)Hashmi Enterprises Limited, Plot 4449, Kamwala Chilumbulu Road, P.O Box 38895, Lusaka, Zambia.

(511) Int.Cl.16

(510) Paper and cardboard; printed matter; bookbinding material; photographs; stationery and office requisites, except furniture; adhesives for stationery or household purposes; drawing materials and materials for artists; paintbrushes; instructional and teaching materials; plastic sheets, films and bags for wrapping and packaging; printers' type, printing blocks.

(526) Proceeding in terms of Section 23 (1)



(540)

---

(210) 139/2025; (220) 24.01.2025

(731)(750)LOLC Finance Zambia, Green City Office Park Suite B9 & b13, Kelvin Siwale Road, Lusaka, , , Zambia

(511) Int.Cl.16

(510) Paper and cardboard; printed matter; bookbinding material; photographs; stationery and office requisites, except furniture; adhesives for stationery or household purposes; artists' and drawing materials; paintbrushes; instructional and teaching materials; plastic sheets, films and bags for wrapping and packaging; printers' type, printing blocks.

(526) Registration of this trademark shall give no exclusive right to the use of the words "Zambia "and Finance" exclusively except for the use of the mark as a whole.



(540)

---

(210) 237/2025; (220) 03.02.2025

(731)(750)Eliana Trust School, Plot No. K45, Off Great North Road, Kabangwe, Lusaka, Zambia.

(511) Int.Cl.16

(510) Paper and Cardboard; printed Matter; and Teaching Materials

(526) Trade mark rights subsist in the mark 'ELIANA' while the elements, words and pictorial representations that are descriptive are non-trade mark matter and therefore non-exclusive



(540)

---

(210) 263/2025; (220) 07.02.2025

(731)(750)Beeline Telecoms Limited, Suit No.1, Unit 2 Counting Square, Thabo Mbeki Road, Lusaka, Zambia.

(511) Int.Cl.9

- (510) Scientific, research, navigation, surveying, photographic, cinematographic, audiovisual, optical, weighing, measuring, signalling, detecting, testing, inspecting, life-saving and teaching apparatus and instruments; apparatus and instruments for conducting, switching, transforming, accumulating, regulating or controlling the distribution or use of electricity; apparatus and instruments for recording, transmitting, reproducing or processing sound, images or data; recorded and downloadable media, computer software, blank digital or analogue recording and storage media; mechanisms for coin-operated apparatus; cash registers, calculating devices; computers and computer peripheral devices; diving suits, divers' masks, ear plugs for divers, nose clips for divers and swimmers, gloves for divers, breathing apparatus for underwater swimming; fire-extinguishing apparatus
- (526) Registration of this trademark shall give no exclusive right to the words 'INSPIRED' or 'CONNECTION' separately apart from the mark as a whole

*ZEDMOBILE INSPIRED CONNECTION*

(540)

---

- (210) 270/2025; (220) 10.02.2025  
(731)(750)Hackberry Farms Limited, Subdiv 19 of 283A,Off Mumbwa Road, Makeni West, Lusaka, Zambia.  
(511) Int.Cl.30  
(510) Ice: ice cubes, ice blocks, crushed ice



(540)

---

- (210) 271/2025; (220) 10.02.2025  
(731)(750)Hackberry Farms Limited, Subdiv 19 of 283A,Off Mumbwa Road, Makeni West, Lusaka, Lusaka, Zambia.  
(511) Int.Cl.29  
(510) Meat, fish, poultry and game; meat extracts; preserved, frozen, dried and cooked fruits and vegetables; jellies, jams, compotes; eggs, milk, cheese, butter, yogurt and other milk products; oils and fats for food.



*Mac'Chicken*  
— FRESH CHICKEN —

(540)

---

(210) 283/2025; (220) 13.02.2025

(731)(750)Colour Rite Chemicals Limited, Plot No. 7157, Mukatasha Road, P.o Box 34159, Lusaka, Zambia.

(511) Int.Cl.2

(510) Enamels of painting, enamel paintings, gloss enamel, paints, vanishes, lacquers; preservatives against rust and against deterioration of wood; colourants, dyes; inks for printing, marking and engraving; raw natural resins; metals in foil and powder form for use in painting, decorating, printing and art.

(526) Registration of this trade mark shall give no exclusive right to use of the word "National", "Gloss" and "Enamel" each separately apart from the mark as a whole.



(540)

---

(210) 333/2025; (220) 20.02.2025

(731)(750)Silvertex Enterprise Limited, Plot 36087 Mumbwa Road, Chinika Industrial Area, Lusaka, Zambia.

(511) Int.Cl.2

(510) Paints, varnishes and lacquers for industry, handicrafts and arts;- thickeners, fixative wood and leather, anti-rust oils for the preservation of wood; dye beverages

(526) Registration of this trade mark shall give no exclusive right to the use of the word "Paints" separately apart from the mark as a whole.



(540)

---

(210) 334/2025; (220) 20.02.2025

(731)(750)Silvertex Enterprise Limited, Plot 36087 Mumbwa Road, Chinika Industrial Area, Lusaka, Zambia.

(511) Int.Cl.12

(510) Rubber material for recapping tyres; - floating anti-pollution barriers; -adhesive tapes, other than stationery and not for medical or household purposes; plastic films, other than for wrapping and packaging, for example, anti-dazzle films for windows; - elastic threads and threads of rubber or plastic, not for textile use; - certain goods made of the materials in this class not otherwise classified by function or purpose, for example, foam supports for flower arrangements, padding and stuffing materials of rubber or plastics, rubber stoppers, shock-absorbing buffers of rubber, rubber bags or envelopes for packaging



(540)

---

(210) 363/2025; (220) 26.02.2025

L)(7 (731)(7 50)Aone Beverages Limited, Plot #10 off Lufubu Road, Kalundu, Lusaka, Zambia.

Int.Cl.32

Non alcoholic Beverages, water, fruit juices

Registration of this trade mark shall give no exclusive right to the use of the word "Clear" separately apart from the mark as a whole.

Clear +

STATUTORY NOTICES UNDER MADRID

ACCEPTED TRADE MARK APPLICATIONS FILED FOR REGISTRATION UNDER THE MADRID PROTOCOL FOR  
THE REGISTRATION OF INTERNATIONAL MARKS. (CA)

(210) 1843389;

(220) 06.02.2025

(731) BELLES MARKS LTD Artemidos 3-5, ARTEMIDOS TOWER, 1st floor, Flat/Office 101 CY-6020 Larnaca, Cyprus

(511) Int.Cl. 33

(510): Alcoholic beverages (except beer).

(540) **DAR1892**

Note: Opposition period for this trademark expires on **13.03.2026**

---

(210) 1843471;

(220) 27.11.2024

(731) SHENZHEN VSTARCAM TECHNOLOGY CO., LTD. Floor 1-4, Building 2, VStarcam Industrial Park, No. 8 Baotian Rd, Shuitian Community, Shiyan Street, Bao'an District, Shenzhen City 518108 Guangdong Province, China

(511) Int.Cl. 09

(510): Computer programs, downloadable; computer peripheral devices; computer software, recorded; intercommunication apparatus; video recorders; camcorders; protection devices for personal use against accidents; theft prevention installations, electric; anti-theft warning apparatus.

(540) The logo for VSTARCAM features a stylized blue 'V' shape to the left of the word 'STARCAM' in a bold, black, sans-serif font.

Note: Opposition period for this trademark expires on **13.03.2026**

---

(210) 1835294;

(220) 09.12.2024

(731) Ningbo Saian New Energy Technology Co., Ltd. 2F-01, No. 1852, Mingguang Road, Jiangshan Town, Yinzhou District, Ningbo City, Zhejiang Province, China

(511) Int.Cl. 09

(510): Batteries, electric; accumulators, electric; mobile power supplies [rechargeable batteries]; mobile phone software applications, downloadable; standby batteries; battery boxes; photovoltaic cells; inverters for power supplies; lithium-ion batteries; rechargeable batteries.

(540) **HICORENREGY**

Note: Opposition period for this trademark expires on **13.03.2026**

---

(210) 1843478;

(220) 26.11.2024

(731) Fujian Hengdu Intellectual Property Agency CO., LTD Room 4402, Building B, Wanda Office Building, No. 721 Baozhou Street, Fengze District, Quanzhou, Fujian, China

(511) Int.Cl. 25

(510): Clothing; swimsuit; slippers; sandals; shoes; hats; hosiery; gloves [clothing]; neckties.

(540) **Devo Life**

Note: Opposition period for this trademark expires on **13.03.2026**

---

(210) 1843486;

(220) 19.12.2024

(731) Shanghai Cheermore Biological Technology Co.,Ltd Room 588, 1st Floor, Building 2, No. 2038 Taihe Road, Baoshan District, Shanghai, China

(511) Int.Cl. 03

(510) Cleansing milk for toilet purposes; cosmetics; beauty masks; sunscreen preparations; skin whitening creams; bath preparations, not for medical purposes; bleaching



preparations [decolorants] for cosmetic purposes; cosmetic creams; make-up removing preparations; cosmetic preparations for skin care.

(540) 

Note: Opposition period for this trademark expires on **13.03.2026**

---

(210) 1843504;

(220) 10.12.2024

(731) Wang Xicheng No. 26053 Third District Market, International Trade Mart, China  
Commodity City, Yiwu City, Zhejiang Province, China

(511) Int.Cl. 03, 21:

(510):

**03** Cosmetic preparations for baths; cosmetic acne creams; anti-freckle creams; sunscreen preparations; cosmetics; cream for whitening the skin; beauty masks; lipsticks; anti-wrinkle creams; cosmetic preparations for slimming purposes.

**21** Eyebrow brushes; eye shadow brushes; cosmetic stamps, sold empty; droppers for cosmetic purposes; eyelash brushes; make-up brushes; make-up sponges; powder puffs; bath sponges; cosmetic utensils.

(540) 

(540)

Note: Opposition period for this trademark expires on **13.03.2026**

(210) 1843534;

(220) 26.12.2024

(731) AUX Air Conditioner Co., Ltd. 1166 Mingguang North Road, Jiangshan Town, Yinzhou District, Ningbo City 315191 Zhejiang Province ,China

(511) Int.Cl. 07

(510): Compressed air machines; air-cooled condensers; pumps [machines]; compressors for air conditioners; aerocondensers; compressors for dehumidifying machines; compressors for refrigerators; pumps [parts of machines, engines or motors]; compressors [machines]; compressors being parts of machines, motors and engines; electric compressors; compressed air pumps.

(540) **AUXSONIC**

Note: Opposition period for this trademark expires on **13.03.2026**

---

(210) 1843555;

(220) 12.12.2024

(731) Zhejiang Lvju Vehicle Industry Co., Ltd. Pingshang Industrial Park, Xinhe Town, Wenling City, Zhejiang Province, China

(511) Int.Cl. 12

(510):Motorcycles; motorcycle frames; motors, electric, for land vehicles; electrically powered scooters [vehicles]; electric bicycles; electric vehicles; motor scooters; hubs for motorcycle wheels; self-balancing two-wheeled electric scooters.

(540) **LVJU**

Note: Opposition period for this trademark expires on **13.03.2026**

(210) 1843578;

(220) 1.10.2024

(731) Guangdong Tutti Hardware Co., Ltd. No. 2-1-1, No. 2-1-2, No. 2-1-3, No. 3-3, hongchong Industries Zone, Zhongchong Committee, Leliu Town, Shunde, Foshan 528322 Guangdong, China

(511) Int.Cl. 21

(510): Utensils for household purposes; epergnes; baskets for household purposes; kitchen utensils; dish drying racks; containers for household or kitchen use; trays for household purposes; kitchen containers; daily glassware (including cups, plates, pots, jars); pottery; liqueur sets; stands for clothes irons; ironing boards; shoe trees; trouser presses; boot jacks; tie presses; drying racks for laundry; clothing stretchers; towel rails and rings; rotary washing lines; cosmetic utensils; ice buckets; cleaning instruments, hand-operated; knife rests; dish racks; cruet stand.

(540) **TUTTI**

Note: Opposition period for this trademark expires on **13.03.2026**

---

(210) 1843687;

(220) 16.12.2024

(731) FUJIAN JINHONGCHANG SPORTING GOODS CO.,LTD. No. 69-1, Lianfa Road, Neihu Industrial Zone, Neikeng Town, Jinjiang City, Quanzhou City 362200 Fujian Province, China

(511) Int.Cl. 25

(510): Waterproof clothing; clothing; hats; leather belts [clothing]; slippers; hosiery; shoes; layettes [clothing]; swimsuits; sports shoes.

**PAKIE**  
**派琦**

(540)

Note: Opposition period for this trademark expires on **13.03.2026**

---

(210) 1843758;

(220) 31.10.2024

(731) ARGYRIA LIMITED Arch. Makariou III, 155 PROTEAS HOUSE, 5th floor CY-3026  
Limassol, Cyprus

(511) Int.Cl. 09, 16, 28

(510):

**09** Apparatus and instruments for recording, transmitting, reproducing or processing sound, images or data; recorded and downloadable media, computer software, blank digital or analogue recording and storage media; mechanisms for coin-operated apparatus; cash registers, calculating devices; computers and computer peripheral devices; clothing for protection against accidents, irradiation and fire; battery jars / accumulator jars; battery boxes / accumulator boxes; phonograph records; anti-glare glasses; money counting and sorting machines; audiovisual teaching apparatus; juke boxes, musical; mechanisms for coin-operated apparatus; mechanisms for counter-operated apparatus; protective suits for aviators; alarm bells, electric; life-saving rafts; scales; weighing machines; chargers for electric accumulators; ticket dispensing terminals, electronic; cabinets for loudspeakers; cinematographic cameras; sound recording carriers; protective helmets; respiratory masks, not for medical purposes; spectacle chains; apparatus for editing cinematographic film; flashing lights [luminous signals]; electric installations for the remote control of industrial operations; marine compasses; thread counters; pedometers; counters; photocopiers [photographic, electrostatic, thermic]; diving suits; counterfeit coin detectors; animated cartoons; cameras [photography]; mechanical signs; cases especially made for photographic apparatus and instruments; invoicing machines; filters for use in photography; gloves for divers; measuring glassware; graduated glassware; clothing for protection against fire; heliographic apparatus; holograms; speed indicators; intercommunication

apparatus; optical lanterns; magic lanterns; signs, luminous; neon signs; spectacles; eyewear; protective masks, not for medical purposes; coin-operated mechanisms for television sets; megaphones; computer memory devices; microphones; batteries, electric; observation instruments; computers; computer programs, recorded; ear plugs for divers; bells [warning devices]; weights; telephone apparatus; thermometers, not for medical purposes; teaching apparatus; signalling whistles; remote control apparatus; binoculars; totalizers; dog whistles; buzzers; directional compasses; video recorders; integrated circuits; chips [integrated circuits]; life jackets; eyeglass cases; computer peripheral devices; acoustic couplers; divers' masks; electronic pens [visual display units]; interfaces for computers; knee-pads for workers; microprocessors; mouse [computer peripheral]; processors [central processing units]; readers [data processing equipment]; electronic agendas; electronic tags for goods; integrated circuit cards [smart cards]; notebook computers; electronic notice boards; shoes for protection against accidents, irradiation and fire; sunglasses; video game cartridges; video screens; goggles for sports; protective helmets for sports; electronic publications, downloadable; computer programs, downloadable; decorative magnets; mouse pads; wrist rests for use with computers; computer game software, recorded; headphones; egg timers [sandglasses]; automated teller machines [ATM]; hands-free kits for telephones; riding helmets; clothing especially made for laboratories; downloadable ring tones for mobile phones; downloadable music files; downloadable image files; USB flash drives; cell phone straps; laptop computers; bags adapted for laptops; sleeves for laptops; computer software applications, downloadable; electronic book readers; smartphones; tablet computers; 3D spectacles; memory cards for video game machines; computer hardware; digital signs; wearable activity trackers; chargers for electronic cigarettes; connected bracelets [measuring instruments]; covers for smartphones; cases for smartphones; reflective safety vests; electronic collars to train animals; joysticks for use with computers, other than for video games; smartglasses; smartwatches; mouth guards for sports; head guards for sports; covers for personal digital assistants [PDAs]; covers for tablet computers; interactive touchscreen terminals; audio interfaces; subwoofers; biochips; virtual reality headsets; electronic interactive whiteboards; electronic key fobs being remote control apparatus; electronic numeric displays; teaching robots; personal digital assistants [PDAs]; computer software platforms, recorded or downloadable; sports whistles; computer screen saver software, recorded or downloadable; downloadable graphics for mobile phones; telecommunication apparatus in the form of jewellery; wearable computers;

wearable video display monitors; data gloves; trackballs [computer peripherals]; downloadable emoticons for mobile phones; telepresence robots; computer game software, downloadable; stands adapted for laptops; headgear being protective helmets; video projectors; downloadable cryptographic keys for receiving and spending crypto assets; downloadable e-wallets; credit card terminals; data sets, recorded or downloadable; head-up display apparatus for vehicles; smart speakers; biometric locks; wearable speakers; wireless speaker microphones; haptic suits, other than for medical purposes; mobile phone chargers; mobile phone ring holders; mobile phone ring stands; headsets; headsets for playing video games; downloadable computer software for managing crypto asset transactions using blockchain technology; portable power chargers; head-mounted displays; portable speakers; cooling pads for laptop computers; dashboard mats adapted for holding mobile telephones and smartphones; dry suits; dive skins; wet suits; humanoid robots having communication and learning functions for assisting and entertaining people; self-checkout terminals; cases for smartphones incorporating a keyboard; video mixing desks; user-programmable humanoid robots, not configured; downloadable digital files authenticated by non-fungible tokens [NFTs]; sunglasses for pets; point-of-sale [POS] terminals; holographic projection apparatus; cryptocurrency hardware wallets; downloadable virtual clothing; virtual reality controllers; downloadable digital music files authenticated by non-fungible tokens [NFTs]; downloadable application software for virtual environments; downloadable computer software applications for minting non-fungible tokens [NFTs]; mobile apps; software for financial services; software for financial information, information analysis; software for brokerage services; computer gaming software; betting software; casino management software; interactive casino games provided through a computer or mobile platform; virtual reality game software; video game programs; game software for metaverse; augmented reality game software; game software for use in virtual environments; interactive software based on artificial intelligence; computer and downloadable computer software and mobile applications and downloadable mobile applications for gaming, interaction with other users regarding gaming; computer and downloadable computer software and mobile applications and downloadable mobile applications for gambling, interaction with other users regarding gambling; computer and downloadable computer software and mobile applications and downloadable mobile applications for social games, skill games, tournaments, leagues, fantasy sports, promotions, sweepstakes and contests; computer software and downloadable computer software and mobile applications and downloadable mobile applications

for providing news, data, information, articles, predictive modeling, statistics, advice and analysis in the fields of gaming; computer software and downloadable computer software and mobile applications and downloadable mobile applications for racing and sports, event wagering predictions and play-by-play real game and event representations; computer software for games of chance on any computerized platform, including wireless telecommunication devices and handheld computers; downloadable software for blockchain applications; software for use in chips, integrated circuits and microcircuits for memory cards; artificial intelligence and machine learning software; software for the integration of artificial intelligence and machine learning in the field of big data; digital solutions provider [DSP] software; software for digital distributed storage; computer network-attached storage [NAS] hardware; interactive software; computer software for encryption; utility, security and cryptography software; application software; information retrieval applications; computer application software for use in implementing the internet of things [IoT]; computer hardware modules for use in electronic devices using the internet of things [IoT]; secure terminals for electronic transactions; computer software relating to the handling of financial transactions; software for processing electronic payments to and from others; authentication software; games software for use with video game consoles; software for consumer video game apparatus; game software for smartphones; game software for tablets; software for arcade video game machines; game software for use on mobile and cellular phones; game software for portable computers; downloadable applications for use with mobile devices; downloadable computer programs for video and computer games; computer software for developing video and computer games; computer software for the development of video and computer games; software for computer and mobile game design and programming; downloadable and recorded computer software development tools; downloadable and recorded computer software for creating computer games, online games, multi-player computer games, interactive game worlds, and related graphic content; downloadable and recorded computer editing software for editing images, sound and video; downloadable and recorded computer software for simulation of physical systems; game engine software for video game development and operation; graphics software for use in creating multi-player game and non-game worlds; downloadable digital files related to computer games and video games authenticated by non-fungible tokens or other digital tokens based on blockchain technology; downloadable virtual goods, namely, computer software programs featuring in-game

resources, tokens and virtual currency for use in video games and online virtual worlds.

- 16** Paper and cardboard; printed matter; bookbinding material; photographs; stationery and office requisites, except furniture; adhesives for stationery or household purposes; drawing materials and materials for artists; paintbrushes; instructional and teaching materials; plastic sheets, films and bags for wrapping and packaging; printers' type, printing blocks; steel letters; steel pens; adhesive tape dispensers [office requisites]; paper; posters; advertisement boards of paper or cardboard; albums; scrapbooks; pictures; prints [engravings]; cigar bands; pencil sharpening machines, electric or non-electric; bookends; hand-rests for painters; aquarelles; watercolors [paintings]; watercolours [paintings]; architects' models; engravings; paintings [pictures], framed or unframed; pencils; newspapers; periodicals; mats of paper for beer glasses; tickets; drawing pads; pads [stationery]; pamphlets; embroidery designs [patterns]; drawing pins; moisteners [office requisites]; painters' brushes; writing or drawing books; trays for sorting and counting money; printing type; note books; cards; charts; teaching materials [except apparatus]; cardboard; cardboard tubes; catalogues; tags for index cards; folders for papers; files [office requisites]; books; letter trays; conical paper bags; correcting ink [heliography]; pencil leads; covers [stationery]; wrappers [stationery]; writing chalk; chalk holders; pencil holders; pencil lead holders; cream containers of paper; transfers [decalcomanias]; decalcomanias; graphic prints; graining combs; drawing boards; drawing materials; drawing instruments; diagrams; envelopes [stationery]; etchings; wrapping paper; packing paper; nibs; typewriters, electric or non-electric; pen cases; boxes for pens; nibs of gold; erasing products; writing materials; shields [paper seals]; erasing shields; rubber erasers; photographs [printed]; ledgers [books]; indexes; forms, printed; office requisites, except furniture; charcoal pencils; stencils [stationery]; galley racks [printing]; printed geographical maps; artists' watercolour saucers; graphic reproductions; engraving plates; printed matter; hand labelling appliances; printers' blankets, not of textile; printing sets, portable [office requisites]; printed publications; manuals [handbooks]; handbooks [manuals]; writing paper; booklets; stationery; parchment paper; stencil cases; canvas for painting; paint boxes for use in schools; plastic film for wrapping; apparatus for mounting photographs; photo-engravings; plans; fountain pens; stencil plates; stencils; portraits; flower-pot covers of paper; covers of paper for flower pots; prospectuses; bookbinding material; cloth for bookbinding; pens [office requisites]; magazines [periodicals]; bookmarks;



bookmarkers; greeting cards; tablemats of paper; desk mats; stamp stands; almanacs; calendars; stands for pens and pencils; bottle envelopes of paper or cardboard; coasters of paper; garbage bags of paper or of plastics; table napkins of paper; place mats of paper; writing cases [stationery]; bottle wrappers of paper or cardboard; towels of paper; labels of paper or cardboard; signboards of paper or cardboard; comic books; musical greeting cards; newsletters; papers for painting and calligraphy; paint trays; packing [cushioning, stuffing] materials of paper or cardboard; printed coupons; stencils for decorating food and beverages; baggage claim check tags of paper; colouring books; colouring pictures; souvenir banknotes; publications and printed matter related to computer games; teaching material in the form of games (books); video game brochures; books for learning to play poker; solution books for computer games; card game strategy magazines; strategy guides for computer games; collectible trading cards.

- 28** Boxing gloves; golf clubs; counters [discs] for games; building games; machines for physical exercises; novelty toys for parties; shin guards [sports articles]; cricket bags; hockey sticks; draughts [games]; dice; chest expanders [exercisers]; discuses for sports; dominoes; chess games; draughtboards; rollers for stationary exercise bicycles; golf bags, with or without wheels; novelty toys for playing jokes; gloves for games; cups for dice; board games; games; rackets; theatrical masks; carnival masks; flippers for swimming; surfboards; dolls' clothes; skittles [games]; backgammon games; sailboards; hang gliders; apparatus for games; appliances for gymnastics; baseball gloves; climbers' harness; elbow guards [sports articles]; knee guards [sports articles]; paragliders; skateboards; golf gloves; table-top games; horseshoe games; bags especially designed for skis; jigsaw puzzles; masts for sailboards; piñatas; amusement machines, automatic and coin-operated; playing cards; electronic targets; athletic supporters [sports articles]; snowboards; gaming machines for gambling; slot machines [gaming machines]; paper party hats; chips for gambling; poles for pole vaulting; water wings; swimming belts; swimming jackets; video game machines; portable games with liquid crystal displays; arcade video game machines; controllers for game consoles; toy figures; dumb-bells; masks [playthings]; golf bag trolleys; joysticks for video games; portable games and toys incorporating telecommunication functions; trading cards for games; flippers for diving; video game consoles; hand-held consoles for playing video games; golf bag tags; bags especially designed for surfboards; action figures; trading card games; card games; gaming keyboards; gaming mice; printed lottery tickets; educational games; electronic games apparatus other than those designed for use

solely with an external display screen or monitor; automatic gaming apparatus not operated with coins and other than those adapted for use with an external display screen or monitor; electronic game consoles; games apparatus adapted for use with an external display screen or monitor; cases for card games; boards adapted for trading card games; bags specially adapted for portable video games; bags specially adapted for handheld video game apparatus; protective cases specially adapted for portable video games; games with regard to fictional characters; coin-operated arcade video game machines.



(540)

Note: Opposition period for this trademark expires on **13.03.2026**

---

(210) 1843775;

(220) 09.01.2025

(731) Hitachi Construction Machinery Co., Ltd. 16-1, Higashiueno 2-chome, Taito-ku Tokyo 110-0015, Japan

(511) Int.Cl. 01, 04, 09, 12, 16, 24, 25, 28

(510):

**01** Chemical additives for lubricants; chemical additives for lubricating oils; liquids for hydraulic circuits; hydraulic oils; hydraulic fluids; all of the aforementioned goods only relate to construction machinery, mining machinery (including off-road dump trucks for mining) or earth-moving machinery.

**04** Lubricants for machines; drilling lubricants; industrial lubricants; motor vehicle lubricants; lubricants; grease for machines; industrial grease; lubricating grease; lubricating oil; all of the aforementioned goods only relate to construction machinery, mining machinery (including off-road dump trucks for mining) or earth-moving machinery.

**07** Coal-cutting machines; well drilling machines; rock drills; truck mills for mining purposes; coal ploughs; haulage apparatus for mining; mining machines and apparatus; mineworking machines; mining machines; ore treating machines; diggers being machines; coal loaders; shredders being machines for industrial use; oil filters; oil filters for motors and engines; filters for motors and engines; waste and trash separator machines; mobile machines, namely, soil improvement equipment and implements namely, vibrators, compactors, and soil mixers; earth moving machines, namely, track loaders, wheel loaders, power-operated chain-type trenching machines for digging trenches; loaders being earth moving machines; backhoes being earth moving machines; loader buckets for excavators; sifting machines; earth augers; pile-drivers and their parts and fittings; pile-extractors; cranes; crawler cranes and their parts and fittings; conveyors being machines and their parts and fittings; power shovels; road rollers and their parts and fittings; mobile cranes; asphalt paving machines; winches; hoists; rubber tracks being parts of crawlers on loading-unloading machines and apparatus; earth compacting machines; earth moving machines; construction machines and apparatus; construction machines and apparatus, and their parts and fittings; construction machines, namely, excavators, backhoes being earth moving machines; rubber tracks being parts of crawlers on construction machines; road making machines; road paving machines; hydraulic pliers being parts of constructing machines; hydraulic excavators; wheel loaders and their structural parts and fittings therefor; teeth for buckets for excavators (replaceable cutting edge attached to the tip of the bucket); buckets for earth moving machines; crawler-tracked loaders; snow ploughs; wood chipping machines; pivoting devices for civil engineering machines and apparatus or loading-unloading machines and apparatus; machine elements not for land vehicles, namely, turntables and their rotating devices; travelling gears for power transmissions and gearing being machine elements not for land vehicles; lubricating pumps; circulating pumps; oil drain pumps; hydraulic motors for excavators; hydraulic cylinders for machines; rotary hydraulic cylinder for metalworking machines; transmissions, other than for land vehicles; transmissions for machines; all of the aforementioned goods only relate to construction machinery, mining machinery (including off-road dump trucks for mining) or earth-moving machinery.

**09** Level measuring machines for surveying; lasers for measuring; measuring instruments; distance measuring apparatus; laser measuring systems; satellite finder meters; temperature sensors; temperature indicators; acceleration sensors; tachometers; angle gauges; barometers; apparatus for recording distance; vibration sensors;

vibration meters; infrared sensors; infrared detectors; surveying instruments; speed indicators; motion sensors; motion detectors; electrical control, testing and monitoring apparatus; television monitors; television apparatus; rearview cameras for off-road dump trucks for mining, truck loaders, power shovels, wheel loaders and wheeled excavators; global positioning system (GPS) receivers; two-way radios; electric and electronic video surveillance installations; electric installations for the remote control of industrial operations; transmitters of electronic signals; display monitors; LCD monitors; downloadable computer software for remote monitoring and analysis; computer programs for monitoring; computer hardware; computer operating programs, recorded; all of the aforementioned goods only relate to construction machinery, mining machinery (including off-road dump trucks for mining) or earth-moving machinery.

- 12** Off-road dump trucks for mining; structural parts and fittings for off-road dump trucks for mining.
- 16** Writing paper; mechanical pencils; ball-point pens; pencils; pocket memorandum books; rubber erasers; writing instruments; pen cases; stationery; calendars; all of the aforementioned goods only relate to construction machinery, mining machinery (including off-road dump trucks for mining) or earth-moving machinery.
- 24** Japanese ceremonial wrapping cloth (fukusa); Japanese general wrapping cloth (furoshiki); towels of textile; handkerchiefs of textile; bath towels; hand towels; all of the aforementioned goods only relate to construction machinery, mining machinery (including off-road dump trucks for mining) or earth-moving machinery.
- 25** Parkas; polo shirts; shirts for suits; rainwear; tee-shirts; formalwear; clothing; socks; neckties; men's socks; ear muffs being clothing; ear warmers being clothes; gloves and mittens being clothing; gloves as clothing; headgear for wear; all of the aforementioned goods only relate to construction machinery, mining machinery (including off-road dump trucks for mining) or earth-moving machinery.
- 28** Toy model off-road dump trucks for mining; toy model power shovels; dolls; all of the aforementioned goods only relate to construction machinery, mining machinery (including off-road dump trucks for mining) or earth-moving machinery.
- 35** Retail services relating to lubricants not for land vehicles except off-road dump trucks for mining, wheel loaders and wheeled excavators; retail services or wholesale services for hydraulic oils not for land vehicles except off-road dump trucks for mining, wheel

loaders and wheeled excavators; retail services or wholesale services for mining machines and apparatus; retail services or wholesale services for construction machines and apparatus, earth moving machinery, and loading-unloading machines and apparatus; retail services or wholesale services for off-road dump trucks for mining, wheel loaders and wheeled excavators; distributorship services in the field of used construction machinery, structural equipment and parts; retail store services for used construction machinery and earth moving machinery, structural equipment and parts; business project management services for construction projects; all of the aforementioned services only relate to construction machinery, mining machinery (including off-road dump trucks for mining) or earth-moving machinery.

**36** Arranging finance for construction projects; financing relating to purchase of construction machinery, civil engineering machinery, or cargo handling machinery; all of the aforementioned services only relate to construction machinery, mining machinery (including off-road dump trucks for mining) or earth-moving machinery.

**37** Construction; construction and maintenance services relating to civil engineering; providing information relating to the position and operating status for construction using construction machinery and equipment; construction consultancy; repair of off-road dump trucks for mining, wheel loaders and wheeled excavators; repair or maintenance of loading-unloading machines and apparatus; repair or maintenance of construction machines and apparatus; repair or maintenance of mining machines and apparatus; providing information relating to location and operating status for maintenance and repair of construction machinery and equipment; providing information relating to location and operating status for maintenance and repair of building machinery and equipment; providing information relating to location and operating status for maintenance and repair of mining machinery and equipment; rental of cranes being construction equipment; rental of construction equipment; information concerning rental of equipment for constructions and buildings; rental of construction machines and apparatus; leasing and rental of hydraulic excavators, wheel loaders, crawler tractor dozers, backhoe loaders, skid-steer loaders, pavers, milling machines, graders, crushing plants, screens, drills, compactors, mining shovels, feller-bunchers, harvesters, forwarders, processors, log loaders, conveyors, and other heavy equipment used in the construction, mining, and forestry industries and other earth moving activities; rental of excavators; rental of mining machines and apparatus; all of the aforementioned services only relate to construction machinery, mining machinery (including off-road dump trucks for mining) or earth-moving machinery.

- 39** Transport of parts and fittings for off-road dump trucks for mining by truck; transport of hydraulic excavators; all of the aforementioned services only relate to construction machinery, mining machinery (including off-road dump trucks for mining) or earth-moving machinery.
- 42** Surveying; conducting engineering surveys; engineering surveying; topographic surveying.



Note: Opposition period for this trademark expires on **13/03/2026**

---

(210) 1843777;

(220) 30.10.2024

(731) ARGYRIA LIMITED Arch. Makariou III, 155 PROTEAS HOUSE, 5th floorCY-3026 Limasso, Cyprus

(511) Int.Cl. 09, 16, 28

(510):

- 09** Apparatus and instruments for recording, transmitting, reproducing or processing sound, images or data; recorded and downloadable media, computer software, blank digital or analogue recording and storage media; mechanisms for coin-operated apparatus; cash registers, calculating devices; computers and computer peripheral devices; clothing for protection against accidents, irradiation and fire; battery jars / accumulator jars; battery boxes / accumulator boxes; phonograph records; anti-glare glasses; money counting and sorting machines; audiovisual teaching apparatus; juke boxes, musical; mechanisms for coin-operated apparatus; mechanisms for counter-operated apparatus; protective suits for aviators; alarm bells, electric; life-saving rafts; scales; weighing machines; chargers for electric accumulators; ticket dispensing terminals, electronic; cabinets for loudspeakers; cinematographic cameras; sound recording carriers; protective helmets; respiratory masks, not for medical purposes; spectacle chains; apparatus for editing cinematographic film; flashing lights [luminous signals]; electric installations for the remote control of industrial operations; marine

compasses; thread counters; pedometers; counters; photocopiers [photographic, electrostatic, thermic]; diving suits; counterfeit coin detectors; animated cartoons; cameras [photography]; mechanical signs; cases especially made for photographic apparatus and instruments; invoicing machines; filters for use in photography; gloves for divers; measuring glassware; graduated glassware; clothing for protection against fire; heliographic apparatus; holograms; speed indicators; intercommunication apparatus; optical lanterns; magic lanterns; signs, luminous; neon signs; spectacles; eyewear; protective masks, not for medical purposes; coin-operated mechanisms for television sets; megaphones; computer memory devices; microphones; batteries, electric; observation instruments; computers; computer programs, recorded; ear plugs for divers; bells [warning devices]; weights; telephone apparatus; thermometers, not for medical purposes; teaching apparatus; signalling whistles; remote control apparatus; binoculars; totalizers; dog whistles; buzzers; directional compasses; video recorders; integrated circuits; chips [integrated circuits]; life jackets; eyeglass cases; computer peripheral devices; acoustic couplers; divers' masks; electronic pens [visual display units]; interfaces for computers; knee-pads for workers; microprocessors; mouse [computer peripheral]; processors [central processing units]; readers [data processing equipment]; electronic agendas; electronic tags for goods; integrated circuit cards [smart cards]; notebook computers; electronic notice boards; shoes for protection against accidents, irradiation and fire; sunglasses; video game cartridges; video screens; goggles for sports; protective helmets for sports; electronic publications, downloadable; computer programs, downloadable; decorative magnets; mouse pads; wrist rests for use with computers; computer game software, recorded; headphones; egg timers [sandglasses]; automated teller machines [ATM]; hands-free kits for telephones; riding helmets; clothing especially made for laboratories; downloadable ring tones for mobile phones; downloadable music files; downloadable image files; USB flash drives; cell phone straps; laptop computers; bags adapted for laptops; sleeves for laptops; computer software applications, downloadable; electronic book readers; smartphones; tablet computers; 3D spectacles; memory cards for video game machines; computer hardware; digital signs; wearable activity trackers; chargers for electronic cigarettes; connected bracelets [measuring instruments]; covers for smartphones; cases for smartphones; reflective safety vests; electronic collars to train animals; joysticks for use with computers, other than for video games; smartglasses; smartwatches; mouth guards for sports; head guards for sports; covers for personal digital assistants [PDAs]; covers for tablet computers; interactive touchscreen

terminals; audio interfaces; subwoofers; biochips; virtual reality headsets; electronic interactive whiteboards; electronic key fobs being remote control apparatus; electronic numeric displays; teaching robots; personal digital assistants [PDAs]; computer software platforms, recorded or downloadable; sports whistles; computer screen saver software, recorded or downloadable; downloadable graphics for mobile phones; telecommunication apparatus in the form of jewellery; wearable computers; wearable video display monitors; data gloves; trackballs [computer peripherals]; downloadable emoticons for mobile phones; telepresence robots; computer game software, downloadable; stands adapted for laptops; headgear being protective helmets; video projectors; downloadable cryptographic keys for receiving and spending crypto assets; downloadable e-wallets; credit card terminals; data sets, recorded or downloadable; head-up display apparatus for vehicles; smart speakers; biometric locks; wearable speakers; wireless speaker microphones; haptic suits, other than for medical purposes; mobile phone chargers; mobile phone ring holders; mobile phone ring stands; headsets; headsets for playing video games; downloadable computer software for managing crypto asset transactions using blockchain technology; portable power chargers; head-mounted displays; portable speakers; cooling pads for laptop computers; dashboard mats adapted for holding mobile telephones and smartphones; dry suits; dive skins; wet suits; humanoid robots having communication and learning functions for assisting and entertaining people; self-checkout terminals; cases for smartphones incorporating a keyboard; video mixing desks; user-programmable humanoid robots, not configured; downloadable digital files authenticated by non-fungible tokens [NFTs]; sunglasses for pets; point-of-sale [POS] terminals; holographic projection apparatus; cryptocurrency hardware wallets; downloadable virtual clothing; virtual reality controllers; downloadable digital music files authenticated by non-fungible tokens [NFTs]; downloadable application software for virtual environments; downloadable computer software applications for minting non-fungible tokens [NFTs]; mobile apps; software for financial services; software for financial information, information analysis; software for brokerage services; computer gaming software; betting software; casino management software; interactive casino games provided through a computer or mobile platform; virtual reality game software; video game programs; game software for metaverse; augmented reality game software; game software for use in virtual environments; interactive software based on artificial intelligence; computer and downloadable computer software and mobile applications and downloadable mobile applications for gaming, interaction with other users regarding gaming; computer and



downloadable computer software and mobile applications and downloadable mobile applications for gambling, interaction with other users regarding gambling; computer and downloadable computer software and mobile applications and downloadable mobile applications for social games, skill games, tournaments, leagues, fantasy sports, promotions, sweepstakes and contests; computer software and downloadable computer software and mobile applications and downloadable mobile applications for providing news, data, information, articles, predictive modeling, statistics, advice and analysis in the fields of gaming; computer software and downloadable computer software and mobile applications and downloadable mobile applications for racing and sports, event wagering predictions and play-by-play real game and event representations; computer software for games of chance on any computerized platform, including wireless telecommunication devices and handheld computers; downloadable software for blockchain applications; software for use in chips, integrated circuits and microcircuits for memory cards; artificial intelligence and machine learning software; software for the integration of artificial intelligence and machine learning in the field of big data; digital solutions provider [DSP] software; software for digital distributed storage; computer network-attached storage [NAS] hardware; interactive software; computer software for encryption; utility, security and cryptography software; application software; information retrieval applications; computer application software for use in implementing the internet of things [IoT]; computer hardware modules for use in electronic devices using the internet of things [IoT]; secure terminals for electronic transactions; computer software relating to the handling of financial transactions; software for processing electronic payments to and from others; authentication software; games software for use with video game consoles; software for consumer video game apparatus; game software for smartphones; game software for tablets; software for arcade video game machines; game software for use on mobile and cellular phones; game software for portable computers; downloadable applications for use with mobile devices; downloadable computer programs for video and computer games; computer software for developing video and computer games; computer software for the development of video and computer games; software for computer and mobile game design and programming; downloadable and recorded computer software development tools; downloadable and recorded computer software for creating computer games, online games, multi-player computer games, interactive game worlds, and related graphic content; downloadable and recorded computer editing software for editing images, sound and video; downloadable and recorded computer software for simulation of

physical systems; game engine software for video game development and operation; graphics software for use in creating multi-player game and non-game worlds; downloadable digital files related to computer games and video games authenticated by non-fungible tokens or other digital tokens based on blockchain technology; downloadable virtual goods, namely, computer software programs featuring in-game resources, tokens and virtual currency for use in video games and online virtual worlds.

- 16** Paper and cardboard; printed matter; bookbinding material; photographs; stationery and office requisites, except furniture; adhesives for stationery or household purposes; drawing materials and materials for artists; paintbrushes; instructional and teaching materials; plastic sheets, films and bags for wrapping and packaging; printers' type, printing blocks; steel letters; steel pens; adhesive tape dispensers [office requisites]; paper; posters; advertisement boards of paper or cardboard; albums; scrapbooks; pictures; prints [engravings]; cigar bands; pencil sharpening machines, electric or non-electric; bookends; hand-rests for painters; aquarelles; watercolors [paintings]; watercolours [paintings]; architects' models; engravings; paintings [pictures], framed or unframed; pencils; newspapers; periodicals; mats of paper for beer glasses; tickets; drawing pads; pads [stationery]; pamphlets; embroidery designs [patterns]; drawing pins; moisteners [office requisites]; painters' brushes; writing or drawing books; trays for sorting and counting money; printing type; note books; cards; charts; teaching materials [except apparatus]; cardboard; cardboard tubes; catalogues; tags for index cards; folders for papers; files [office requisites]; books; letter trays; conical paper bags; correcting ink [heliography]; pencil leads; covers [stationery]; wrappers [stationery]; writing chalk; chalk holders; pencil holders; pencil lead holders; cream containers of paper; transfers [decalcomanias]; decalcomanias; graphic prints; graining combs; drawing boards; drawing materials; drawing instruments; diagrams; envelopes [stationery]; etchings; wrapping paper; packing paper; nibs; typewriters, electric or non-electric; pen cases; boxes for pens; nibs of gold; erasing products; writing materials; shields [paper seals]; erasing shields; rubber erasers; photographs [printed]; ledgers [books]; indexes; forms, printed; office requisites, except furniture; charcoal pencils; stencils [stationery]; galley racks [printing]; printed geographical maps; artists' watercolour saucers; graphic reproductions; engraving plates; printed matter; hand labelling appliances; printers' blankets, not of textile; printing sets, portable [office requisites]; printed publications; manuals [handbooks]; handbooks [manuals]; writing paper; booklets; stationery;

parchment paper; stencil cases; canvas for painting; paint boxes for use in schools; plastic film for wrapping; apparatus for mounting photographs; photo-engravings; plans; fountain pens; stencil plates; stencils; portraits; flower-pot covers of paper; covers of paper for flower pots; prospectuses; bookbinding material; cloth for bookbinding; pens [office requisites]; magazines [periodicals]; bookmarks; bookmarkers; greeting cards; tablemats of paper; desk mats; stamp stands; almanacs; calendars; stands for pens and pencils; bottle envelopes of paper or cardboard; coasters of paper; garbage bags of paper or of plastics; table napkins of paper; place mats of paper; writing cases [stationery]; bottle wrappers of paper or cardboard; towels of paper; labels of paper or cardboard; signboards of paper or cardboard; comic books; musical greeting cards; newsletters; papers for painting and calligraphy; paint trays; packing [cushioning, stuffing] materials of paper or cardboard; printed coupons; stencils for decorating food and beverages; baggage claim check tags of paper; colouring books; colouring pictures; souvenir banknotes; publications and printed matter related to computer games; teaching material in the form of games (books); video game brochures; books for learning to play poker; solution books for computer games; card game strategy magazines; strategy guides for computer games; collectible trading cards.

- 28** Boxing gloves; golf clubs; counters [discs] for games; building games; machines for physical exercises; novelty toys for parties; shin guards [sports articles]; cricket bags; hockey sticks; draughts [games]; dice; chest expanders [exercisers]; discuses for sports; dominoes; chess games; draughtboards; rollers for stationary exercise bicycles; golf bags, with or without wheels; novelty toys for playing jokes; gloves for games; cups for dice; board games; games; rackets; theatrical masks; carnival masks; flippers for swimming; surfboards; dolls' clothes; skittles [games]; backgammon games; sailboards; hang gliders; apparatus for games; appliances for gymnastics; baseball gloves; climbers' harness; elbow guards [sports articles]; knee guards [sports articles]; paragliders; skateboards; golf gloves; table-top games; horseshoe games; bags especially designed for skis; jigsaw puzzles; masts for sailboards; piñatas; amusement machines, automatic and coin-operated; playing cards; electronic targets; athletic supporters [sports articles]; snowboards; gaming machines for gambling; slot machines [gaming machines]; paper party hats; chips for gambling; poles for pole vaulting; water wings; swimming belts; swimming jackets; video game machines; portable games with liquid crystal displays; arcade video game machines; controllers for game consoles; toy figures; dumb-bells; masks [playthings]; golf bag

trolleys; joysticks for video games; portable games and toys incorporating telecommunication functions; trading cards for games; flippers for diving; video game consoles; hand-held consoles for playing video games; golf bag tags; bags especially designed for surfboards; action figures; trading card games; card games; gaming keyboards; gaming mice; printed lottery tickets; educational games; electronic games apparatus other than those designed for use solely with an external display screen or monitor; automatic gaming apparatus not operated with coins and other than those adapted for use with an external display screen or monitor; electronic game consoles; games apparatus adapted for use with an external display screen or monitor; cases for card games; boards adapted for trading card games; bags specially adapted for portable video games; bags specially adapted for handheld video game apparatus; protective cases specially adapted for portable video games; games with regard to fictional characters; coin-operated arcade video game machines.



(540)

Note: Opposition period for this trademark expires on **13.03.2026**

(210) 1843778;

(220) 31.10.2024

(731) ARGYRIA LIMITED Arch. Makariou III, 155 PROTEAS HOUSE, 5th floor CY-3026  
Limassol, Cyprus

(511) Int.Cl. 09, 16, 28

(510):

**09** Apparatus and instruments for recording, transmitting, reproducing or processing sound, images or data; recorded and downloadable media, computer software, blank digital or analogue recording and storage media; mechanisms for coin-operated apparatus; cash registers, calculating devices; computers and computer peripheral devices; clothing for protection against accidents, irradiation and fire; battery jars / accumulator jars; battery boxes / accumulator boxes; phonograph records; anti-glare glasses; money counting and sorting machines; audiovisual teaching apparatus; juke boxes, musical; mechanisms for coin-operated apparatus; mechanisms for counter-

operated apparatus; protective suits for aviators; alarm bells, electric; life-saving rafts; scales; weighing machines; chargers for electric accumulators; ticket dispensing terminals, electronic; cabinets for loudspeakers; cinematographic cameras; sound recording carriers; protective helmets; respiratory masks, not for medical purposes; spectacle chains; apparatus for editing cinematographic film; flashing lights [luminous signals]; electric installations for the remote control of industrial operations; marine compasses; thread counters; pedometers; counters; photocopiers [photographic, electrostatic, thermic]; diving suits; counterfeit coin detectors; animated cartoons; cameras [photography]; mechanical signs; cases especially made for photographic apparatus and instruments; invoicing machines; filters for use in photography; gloves for divers; measuring glassware; graduated glassware; clothing for protection against fire; heliographic apparatus; holograms; speed indicators; intercommunication apparatus; optical lanterns; magic lanterns; signs, luminous; neon signs; spectacles; eyewear; protective masks, not for medical purposes; coin-operated mechanisms for television sets; megaphones; computer memory devices; microphones; batteries, electric; observation instruments; computers; computer programs, recorded; ear plugs for divers; bells [warning devices]; weights; telephone apparatus; thermometers, not for medical purposes; teaching apparatus; signalling whistles; remote control apparatus; binoculars; totalizers; dog whistles; buzzers; directional compasses; video recorders; integrated circuits; chips [integrated circuits]; life jackets; eyeglass cases; computer peripheral devices; acoustic couplers; divers' masks; electronic pens [visual display units]; interfaces for computers; knee-pads for workers; microprocessors; mouse [computer peripheral]; processors [central processing units]; readers [data processing equipment]; electronic agendas; electronic tags for goods; integrated circuit cards [smart cards]; notebook computers; electronic notice boards; shoes for protection against accidents, irradiation and fire; sunglasses; video game cartridges; video screens; goggles for sports; protective helmets for sports; electronic publications, downloadable; computer programs, downloadable; decorative magnets; mouse pads; wrist rests for use with computers; computer game software, recorded; headphones; egg timers [sandglasses]; automated teller machines [ATM]; hands-free kits for telephones; riding helmets; clothing especially made for laboratories; downloadable ring tones for mobile phones; downloadable music files; downloadable image files; USB flash drives; cell phone straps; laptop computers; bags adapted for laptops; sleeves for laptops; computer software applications, downloadable; electronic book readers; smartphones; tablet computers; 3D spectacles; memory cards for video game machines; computer hardware; digital signs; wearable activity trackers; chargers for

electronic cigarettes; connected bracelets [measuring instruments]; covers for smartphones; cases for smartphones; reflective safety vests; electronic collars to train animals; joysticks for use with computers, other than for video games; smartglasses; smartwatches; mouth guards for sports; head guards for sports; covers for personal digital assistants [PDAs]; covers for tablet computers; interactive touchscreen terminals; audio interfaces; subwoofers; biochips; virtual reality headsets; electronic interactive whiteboards; electronic key fobs being remote control apparatus; electronic numeric displays; teaching robots; personal digital assistants [PDAs]; computer software platforms, recorded or downloadable; sports whistles; computer screen saver software, recorded or downloadable; downloadable graphics for mobile phones; telecommunication apparatus in the form of jewellery; wearable computers; wearable video display monitors; data gloves; trackballs [computer peripherals]; downloadable emoticons for mobile phones; telepresence robots; computer game software, downloadable; stands adapted for laptops; headgear being protective helmets; video projectors; downloadable cryptographic keys for receiving and spending crypto assets; downloadable e-wallets; credit card terminals; data sets, recorded or downloadable; head-up display apparatus for vehicles; smart speakers; biometric locks; wearable speakers; wireless speaker microphones; haptic suits, other than for medical purposes; mobile phone chargers; mobile phone ring holders; mobile phone ring stands; headsets; headsets for playing video games; downloadable computer software for managing crypto asset transactions using blockchain technology; portable power chargers; head-mounted displays; portable speakers; cooling pads for laptop computers; dashboard mats adapted for holding mobile telephones and smartphones; dry suits; dive skins; wet suits; humanoid robots having communication and learning functions for assisting and entertaining people; self-checkout terminals; cases for smartphones incorporating a keyboard; video mixing desks; user-programmable humanoid robots, not configured; downloadable digital files authenticated by non-fungible tokens [NFTs]; sunglasses for pets; point-of-sale [POS] terminals; holographic projection apparatus; cryptocurrency hardware wallets; downloadable virtual clothing; virtual reality controllers; downloadable digital music files authenticated by non-fungible tokens [NFTs]; downloadable application software for virtual environments; downloadable computer software applications for minting non-fungible tokens [NFTs]; mobile apps; software for financial services; software for financial information, information analysis; software for brokerage services; computer gaming software; betting software; casino management software; interactive casino games provided through a computer or mobile platform; virtual reality game software; video game

programs; game software for metaverse; augmented reality game software; game software for use in virtual environments; interactive software based on artificial intelligence; computer and downloadable computer software and mobile applications and downloadable mobile applications for gaming, interaction with other users regarding gaming; computer and downloadable computer software and mobile applications and downloadable mobile applications for gambling, interaction with other users regarding gambling; computer and downloadable computer software and mobile applications and downloadable mobile applications for social games, skill games, tournaments, leagues, fantasy sports, promotions, sweepstakes and contests; computer software and downloadable computer software and mobile applications and downloadable mobile applications for providing news, data, information, articles, predictive modeling, statistics, advice and analysis in the fields of gaming; computer software and downloadable computer software and mobile applications and downloadable mobile applications for racing and sports, event wagering predictions and play-by-play real game and event representations; computer software for games of chance on any computerized platform, including wireless telecommunication devices and handheld computers; downloadable software for blockchain applications; software for use in chips, integrated circuits and microcircuits for memory cards; artificial intelligence and machine learning software; software for the integration of artificial intelligence and machine learning in the field of big data; digital solutions provider [DSP] software; software for digital distributed storage; computer network-attached storage [NAS] hardware; interactive software; computer software for encryption; utility, security and cryptography software; application software; information retrieval applications; computer application software for use in implementing the internet of things [IoT]; computer hardware modules for use in electronic devices using the internet of things [IoT]; secure terminals for electronic transactions; computer software relating to the handling of financial transactions; software for processing electronic payments to and from others; authentication software; games software for use with video game consoles; software for consumer video game apparatus; game software for smartphones; game software for tablets; software for arcade video game machines; game software for use on mobile and cellular phones; game software for portable computers; downloadable applications for use with mobile devices; downloadable computer programs for video and computer games; computer software for developing video and computer games; computer software for the development of video and computer games; software for computer and mobile game design and programming; downloadable and recorded computer

software development tools; downloadable and recorded computer software for creating computer games, online games, multi-player computer games, interactive game worlds, and related graphic content; downloadable and recorded computer editing software for editing images, sound and video; downloadable and recorded computer software for simulation of physical systems; game engine software for video game development and operation; graphics software for use in creating multi-player game and non-game worlds; downloadable digital files related to computer games and video games authenticated by non-fungible tokens or other digital tokens based on blockchain technology; downloadable virtual goods, namely, computer software programs featuring in-game resources, tokens and virtual currency for use in video games and online virtual worlds.

- 16** Paper and cardboard; printed matter; bookbinding material; photographs; stationery and office requisites, except furniture; adhesives for stationery or household purposes; drawing materials and materials for artists; paintbrushes; instructional and teaching materials; plastic sheets, films and bags for wrapping and packaging; printers' type, printing blocks; steel letters; steel pens; adhesive tape dispensers [office requisites]; paper; posters; advertisement boards of paper or cardboard; albums; scrapbooks; pictures; prints [engravings]; cigar bands; pencil sharpening machines, electric or non-electric; bookends; hand-rests for painters; aquarelles; watercolors [paintings]; watercolours [paintings]; architects' models; engravings; paintings [pictures], framed or unframed; pencils; newspapers; periodicals; mats of paper for beer glasses; tickets; drawing pads; pads [stationery]; pamphlets; embroidery designs [patterns]; drawing pins; moisteners [office requisites]; painters' brushes; writing or drawing books; trays for sorting and counting money; printing type; note books; cards; charts; teaching materials [except apparatus]; cardboard; cardboard tubes; catalogues; tags for index cards; folders for papers; files [office requisites]; books; letter trays; conical paper bags; correcting ink [heliography]; pencil leads; covers [stationery]; wrappers [stationery]; writing chalk; chalk holders; pencil holders; pencil lead holders; cream containers of paper; transfers [decalcomanias]; decalcomanias; graphic prints; graining combs; drawing boards; drawing materials; drawing instruments; diagrams; envelopes [stationery]; etchings; wrapping paper; packing paper; nibs; typewriters, electric or non-electric; pen cases; boxes for pens; nibs of gold; erasing products; writing materials; shields [paper seals]; erasing shields; rubber erasers; photographs [printed]; ledgers [books]; indexes; forms, printed; office requisites, except furniture; charcoal pencils; stencils [stationery]; galley racks [printing]; printed geographical maps; artists'



watercolour saucers; graphic reproductions; engraving plates; printed matter; hand labelling appliances; printers' blankets, not of textile; printing sets, portable [office requisites]; printed publications; manuals [handbooks]; handbooks [manuals]; writing paper; booklets; stationery; parchment paper; stencil cases; canvas for painting; paint boxes for use in schools; plastic film for wrapping; apparatus for mounting photographs; photo-engravings; plans; fountain pens; stencil plates; stencils; portraits; flower-pot covers of paper; covers of paper for flower pots; prospectuses; bookbinding material; cloth for bookbinding; pens [office requisites]; magazines [periodicals]; bookmarks; bookmarkers; greeting cards; tablemats of paper; desk mats; stamp stands; almanacs; calendars; stands for pens and pencils; bottle envelopes of paper or cardboard; coasters of paper; garbage bags of paper or of plastics; table napkins of paper; place mats of paper; writing cases [stationery]; bottle wrappers of paper or cardboard; towels of paper; labels of paper or cardboard; signboards of paper or cardboard; comic books; musical greeting cards; newsletters; papers for painting and calligraphy; paint trays; packing [cushioning, stuffing] materials of paper or cardboard; printed coupons; stencils for decorating food and beverages; baggage claim check tags of paper; colouring books; colouring pictures; souvenir banknotes; publications and printed matter related to computer games; teaching material in the form of games (books); video game brochures; books for learning to play poker; solution books for computer games; card game strategy magazines; strategy guides for computer games; collectible trading cards.

- 28** Boxing gloves; golf clubs; counters [discs] for games; building games; machines for physical exercises; novelty toys for parties; shin guards [sports articles]; cricket bags; hockey sticks; draughts [games]; dice; chest expanders [exercisers]; discuses for sports; dominoes; chess games; draughtboards; rollers for stationary exercise bicycles; golf bags, with or without wheels; novelty toys for playing jokes; gloves for games; cups for dice; board games; games; rackets; theatrical masks; carnival masks; flippers for swimming; surfboards; dolls' clothes; skittles [games]; backgammon games; sailboards; hang gliders; apparatus for games; appliances for gymnastics; baseball gloves; climbers' harness; elbow guards [sports articles]; knee guards [sports articles]; paragliders; skateboards; golf gloves; table-top games; horseshoe games; bags especially designed for skis; jigsaw puzzles; masts for sailboards; piñatas; amusement machines, automatic and coin-operated; playing cards; electronic targets; athletic supporters [sports articles]; snowboards; gaming machines for gambling; slot machines [gaming machines]; paper party hats; chips for gambling; poles for pole vaulting; water wings;

swimming belts; swimming jackets; video game machines; portable games with liquid crystal displays; arcade video game machines; controllers for game consoles; toy figures; dumb-bells; masks [playthings]; golf bag trolleys; joysticks for video games; portable games and toys incorporating telecommunication functions; trading cards for games; flippers for diving; video game consoles; hand-held consoles for playing video games; golf bag tags; bags especially designed for surfboards; action figures; trading card games; card games; gaming keyboards; gaming mice; printed lottery tickets; educational games; electronic games apparatus other than those designed for use solely with an external display screen or monitor; automatic gaming apparatus not operated with coins and other than those adapted for use with an external display screen or monitor; electronic game consoles; games apparatus adapted for use with an external display screen or monitor; cases for card games; boards adapted for trading card games; bags specially adapted for portable video games; bags specially adapted for handheld video game apparatus; protective cases specially adapted for portable video games; games with regard to fictional characters; coin-operated arcade video game machines.



(540)

Note: Opposition period for this trademark expires on **13.03.2026**

---

(210) 1843782;

(220) 26.11.2024

(731) Beijing Dajia Internet Information Technology Co., Ltd. Room 101, 8th Floor, Building 12, No. 16 Xierqi West Road, Haidian District Beijing, China

(511) Int.Cl. 09

(510): Computer software platforms, recorded or downloadable; quantum computers; computer programs for using the Internet and the World Wide Web; downloadable computer software applications for mobile phones; data sets, recorded or

downloadable; downloadable computer software for collecting, analyzing and organizing data in the field of deep learning; computer peripheral devices; computer software applications, downloadable; data processing apparatus; computer chatbot software for simulating conversations.

(540) **KLING**

Note: Opposition period for this trademark expires on **13.03.2026**

---

(210) 1843799;

(220) 26.12.2024

(731) Euro Games Technology Ltd. 6 Panorama Sofia Str., Richhill Business Center, ground floor, Vitosha Region BG-1766 Sofia, Bulgaria

(511) Int.Cl. 09, 28

(510):

**09** Operating computer software for main frame computers; monitors (computer hardware); computer hardware; apparatus for recording images; monitors (computer programs); computer game programs; recorded computer game programs; apparatus for recording, transmission or reproduction of sound or images; communications servers (computer hardware); electronic components for gambling machines; computer application software featuring games and gaming; computer software for the administration of on-line games and gaming; computer hardware for games and gaming; computer systems; computer operating system software; computer terminals; interactive terminals; multimedia terminals; electronic terminals for generating lottery tickets; interactive touch screen terminals; computer touchscreens; electronic display panels; liquid crystal display screens; digital signage display panels; multimedia software; multimedia apparatus and instruments; interactive multimedia software for playing games; computer screens; lcd large-screen displays; liquid crystal displays [lcds] for home theatres; media streaming software; computer application software for

streaming audio-visual media content via the internet; computer gaming software; software; computer software packages; computer software, recorded; software drivers; virtual reality software; games software; entertainment software for computer games; computer programs for network management; electronic lottery tickets; computer software platforms; operating systems; interactive computer systems; operating system programs; computer game software for use with on-line interactive games; interactive casino games provided through a computer or mobile platform; electronic ticket examination machines; software for slot machines, betting software, software for video slot games, for casino games, for gambling and bingo games, provided online or through computer networks and that can be played on any type of computer device, including arcade games, personal computers, portable devices and mobile phones; computer hardware and software for gambling, gambling machines, gambling games on the internet and via telecommunication network.

- 28** Gaming machines for gambling; chips for gambling; mah-jong; arcade games; gambling machines operating with coins, notes and cards; games; electronic games; parlor games; gaming chips; gaming tables; slot machines [gaming machines]; LCD game machines; slot machines and gaming devices; coin-operated amusement machines; roulette chips; poker chips; chips and dice [gaming equipment]; gaming equipment for casinos; roulette tables; gaming roulette wheels; casino games; gambling machines and amusement machines, automatic and coin-operated; coin-operated amusement machines and / or electronic coin-operated amusement machines with or without the possibility of gain; boxes for coin-operated amusement machines, slot machines and gaming machines; electronic or electrotechnical amusement machines and apparatus, gaming machines, coin-operated entertainment machines; housings for coin-operated amusement machines, gaming equipment, gaming machines, machines for gambling; electropneumatic and electrical gambling machines (slot machines); lottery games; electronic targets for games and sports; parlor game equipment and accessories not included in other classes, in particular tokens, chips, marbles; parlor games, apparatus, equipment and accessories therefor, not included in other classes, in particular electronic targets, backgammon, scratch cards, playing cards, lottery cards, dice; lottery tickets; printed lottery tickets; lottery scratch cards; scratch cards for playing lottery games.

(540) **Dazzling Rolls**

Note: Opposition period for this trademark expires on **13.03.2026**

---

(210) 1842209;

(220) 10.10.2024

(731) Euro Games Technology Ltd. Panorama Sofia Str. 6, Richhill Business Center, ground floor BG-1766 Vitosha Region, Sofia, Bulgaria.

(511) Int.Cl. 09, 28

(510):

**09** Operating computer software for main frame computers; monitors (computer hardware); computer hardware; apparatus for recording images; monitors (computer programs); computer game programs; recorded computer game programs; apparatus for recording, transmission or reproduction of sound or images; communications servers (computer hardware); electronic components for gambling machines; computer application software featuring games and gaming; computer software for the administration of on-line games and gaming; computer hardware for games and gaming; computer hardware and software for gambling, gambling machines, gambling games on the internet and via telecommunication network; computer systems; computer operating system software; computer terminals; interactive terminals; multimedia terminals; electronic terminals for generating lottery tickets; interactive touch screen terminals; computer touchscreens; electronic display panels; liquid crystal display screens; digital signage display panels; multimedia software; multimedia apparatus and instruments; interactive multimedia software for playing games; computer screens; LCD large-screen displays; liquid crystal displays [LCDs] for home theatres; media streaming software; computer application software for streaming audio-visual media content via the internet; computer gaming software; software drivers; virtual reality software; games software; entertainment software for computer games; computer programs for network management; electronic lottery tickets; computer software platforms; operating systems; interactive computer systems; operating system programs; computer game software for use with on-line interactive games; interactive casino games provided through a computer or mobile

platform; electronic ticket examination machines; software for slot machines, betting software, software for video slot games, for casino games, for gambling and bingo games, provided online or through computer networks and that can be played on any type of computer device, including arcade games, personal computers, portable devices and mobile phones; software; computer software packages; computer software, recorded.

**28** Gaming machines for gambling; chips for gambling; mah-jong; arcade games; gambling machines operating with coins, notes and cards; games; electronic games; parlor games; gaming chips; gaming tables; slot machines [gaming machines]; LCD game machines; slot machines and gaming devices; coin-operated amusement machines; roulette chips; poker chips; chips and dice [gaming equipment]; gaming equipment for casinos; roulette tables; gaming roulette wheels; casino games; gambling machines and amusement machines, automatic and coin-operated; coin-operated amusement machines and/or electronic coin-operated amusement machines with or without the possibility of gain; boxes for coin-operated amusement machines, slot machines and gaming machines; electronic or electrotechnical amusement machines and apparatus, gaming machines, coin-operated entertainment machines; housings for coin-operated amusement machines, gaming equipment, gaming machines, machines for gambling; electropneumatic and electrical gambling machines (slot machines); lottery games; electronic targets for games and sports; parlor game equipment and accessories therefor, included in this class, in particular gaming tokens, chips and marbles; parlor games, game apparatus and equipment and accessories therefor, included in this class, in particular electronic targets, backgammon games, scratch cards, playing cards, lottery cards, dice; lottery tickets; printed lottery tickets; lottery scratch cards; scratch cards for playing lottery games.



(540)

Note: Opposition period for this trademark expires on **13.03.2026**

(210) 1842334;

(220) 10.01.2025

(731) Apple Inc. One Apple Park Way Cupertino CA 95014, United States of America.

(511) Int.Cl. 09

(510) Downloadable audio files, image files, video files, music files and multimedia content; downloadable audio and visual recordings, musical recordings, movies, films and television shows; downloadable films and videos featuring 3D and 360-degree viewing in the field of entertainment and sports.

(540)  Immersive

Note: Opposition period for this trademark expires on **06.03.2026**

(210) 1842691;

(220) 21.11.2024

(731) Billion Hearts Software Technologies Private Limited, Flat B-951, Tower B, Divyashree 77 Place, Kundalahalli, Bangalore North, Bangalore Karnataka 560037, India

(511) Int.Cl. 09:

(510) Downloadable software, computer software, downloadable; computer software, recorded, downloadable emoticons for mobile phones, downloadable graphics for mobile phones, downloadable image files, downloadable music files, downloadable ring tones for mobile phones, electronic publications, downloadable.



(540)

Note: Opposition period for this trademark expires on **06.03.2026**

(210) 1842721;

(220) 30.08.2024

(731) KOTAN BAU YAPI SANAYI VE TICARET ANONİM ŞİRKETİ YASSIÖREN MAH. MEDİHA SK.  
KOTAN BAU YAPI 5 1 Arnavutköy İstanbul, Turkey

(511) Int.Cl. 07

(510): Machines used for processing wood, machines used for processing metal, machines used for processing glass, machines used for processing plastic materials, machines used for processing minerals, construction machines, construction machinery, mortar mixers, mortar transfer machines, screed mixers, screed transferring machines, plastering machines, concrete transfer machines, concrete mixers, concrete pumps, screed machines, concrete machines, mortar pumps, robotic mechanisms for construction, lifting machines, transporting machines, conveying machines, robotic mechanisms for lifting, robotic mechanisms for transporting, robotic mechanisms for conveying, elevators, escalators, cranes, agriculture machines, livestock machines, farming machines, robotic mechanisms for agriculture, livestock, farming, motors except for land vehicles, electric motors except for land vehicles, motor parts except for land vehicles, bearings, ball bearings, roller bearings, tire removal and installation machines, alternators, generators, electric generators, solar-powered generators, painting machines, automatic paint sprayers, electric stapling machines, electric adhesive guns, spray guns for compressed air or liquid spraying machines, electric hand drills, powered hand saws, jigsaws, spiral machines, compressed air producers, compressors, car washing machines, robots for car washing, welding machines, robots for welding, printing machines, packaging machines, filling machines, capping machines, sealing machines, labeling machines, sorting machines, textile machines, sewing machines, fuel pumps for engines, electric kitchen appliances for chopping, grinding, crushing, whipping, and mixing, washing machines, dishwashing machines, electric machines for cleaning floors, carpets and floorings, vacuum cleaners and their parts.

(540)



Note: Opposition period for this trademark expires on **06.03.2026**



---

(210) 1842893;

(220) 21.11.2024

(731) Euro Games Technology Ltd. Panorama Sofia Str. 6, Richhill Business Center, ground floor BG-1766 Vitosha Region, Sofia, Bulgaria.

(511) Int.Cl. 09, 28, 41:

(510):

**09** Operating computer software for main frame computers; monitors (computer hardware); computer hardware; apparatus for recording images; monitors (computer programs); computer game programs; recorded computer game programs; apparatus for recording, transmission or reproduction of sound or images; communications servers (computer hardware); electronic components for gambling machines; computer application software featuring games and gaming; computer software for the administration of on-line games and gaming; computer hardware for games and gaming; computer systems; computer operating system software; computer terminals; interactive terminals; multimedia terminals; electronic terminals for generating lottery tickets; interactive touch screen terminals; computer touchscreens; electronic display panels; liquid crystal display screens; digital signage display panels; multimedia software; multimedia apparatus and instruments; interactive multimedia software for playing games; computer screens; lcd large-screen displays; liquid crystal displays [lcds] for home theatres; media streaming software; computer application software for streaming audio-visual media content via the internet; computer gaming software; software; computer software packages; computer software, recorded; software drivers; virtual reality software; games software; entertainment software for computer games; computer programs for network management; electronic lottery tickets; computer software platforms; operating systems; interactive computer systems; operating system programs; computer game software for use with on-line interactive games; interactive casino games provided through a computer or mobile platform; electronic ticket examination machines; software for slot machines, betting software, software for video slot games, for casino games, for gambling and bingo games, provided online or through computer networks and that can be played on any type of computer device, including arcade games, personal computers, portable devices and mobile phones; computer hardware and software for gambling, gambling machines, gambling games on the internet and via telecommunication network.

**28** Gaming machines for gambling; chips for gambling; mah-jong; arcade games; gambling machines operating with coins, notes and cards; games; electronic games; parlor games; gaming chips; gaming tables; slot machines [gaming machines]; LCD game machines; slot machines and gaming devices; coin-operated amusement machines; roulette chips; poker chips; chips and dice [gaming equipment]; gaming equipment for casinos; roulette tables; gaming roulette wheels; casino games; gambling machines and amusement machines, automatic and coin-operated; coin-operated amusement machines and / or electronic coin-operated amusement machines with or without the possibility of gain; boxes for coin-operated amusement machines, slot machines and gaming machines; electronic or electrotechnical amusement machines and apparatus, gaming machines, coin-operated entertainment machines; housings for coin-operated amusement machines, gaming equipment, gaming machines, machines for gambling; electropneumatic and electrical gambling machines (slot machines); lottery games; electronic targets for games and sports; parlor game equipment and accessories not included in other classes, in particular tokens, chips, marbles; parlor games, apparatus, equipment and accessories therefor, not included in other classes, in particular electronic targets, backgammon, scratch cards, playing cards, lottery cards, dice; lottery tickets; printed lottery tickets; lottery scratch cards; scratch cards for playing lottery games.

## (540) **Burning Rolls**

Note: Opposition period for this trademark expires on **06.03.2026**

---

(210) 1843473;

(220) 03.12.2024

(731) Shanghai Tobacco Group Beijing Cigarette Factory Co.,Ltd. No.99 WanSheng NanJie TongZhou District 101121 Beijing, China.

(511) Int.Cl. 34

(510): Cigarettes; cigars; tobacco; tobacco pipes; cigarette cases; ashtrays for smokers; matches; lighters for smokers; cigarette paper; electronic cigarettes; electronic cigarette liquid [e-liquid].

(540) **ZNH**

Note: Opposition period for this trademark expires on **06.03.2026**

---

(210) 1842394;

(220) 03.01.2025

(731) VENUS MANAGEMENT PTE. LTD. 111 NORTH BRIDGE ROAD, #21-03 PENINSULA PLAZA  
SINGAPORE 179098, Singapore.

(511) Int.Cl. 34

(510): Electric cigarettes [electronic cigarettes]; liquids for electronic cigarettes; electronic cigarette cases; holders for electronic cigarettes; cases for electronic cigarettes; electronic cigarettes; tobacco substitutes; electronic cigarettes and oral vaporizers for smokers; oral vaporizers for smokers; vaporizers being smokers' requisites; refill cartridges for electronic cigarettes; electronic cigarette atomizers; boxes for electronic cigarettes; cartridges for electronic cigarettes; electronic cigarette liquid [e-liquid] comprised of flavourings in liquid form used to refill electronic cigarette cartridges; cleaning brushes specially adapted for electronic cigarettes; cleaning sticks specially adapted for electronic cigarettes; electronic cigarette lighters; electronic cigars; electronic smoking devices; flavourings, other than essential oils, for use in electronic cigarettes; smokers' articles; cigarettes; cigars; tobacco; cigarette filters; cigarette holders; cigarette paper; cigarette cases; lighters for smokers; disposable oral vaporizers for smoking purposes sold filled with vegetable glycerin; oral vaporizers for smoking purposes sold filled with vegetable glycerin.



(540)

Note: Opposition period for this trademark expires on **06.03.2026**

---

(210) 1842501;

(220) 30.09.2024

(731) Euro Games Technology Ltd. Panorama Sofia Str. 6, Richhill Business Center, ground floor BG-1766 Vitosha Region, Sofia, Bulgaria

(511) Int.Cl. 09, 28

(510):

**09** Operating computer software for main frame computers; monitors (computer hardware); computer hardware; apparatus for recording images; monitors (computer programs); computer game programs; recorded computer game programs; apparatus for recording, transmission or reproduction of sound or images; communications servers (computer hardware); electronic components for gambling machines; computer application software featuring games and gaming; computer software for the administration of on-line games and gaming; computer hardware for games and gaming; computer hardware and software for gambling, gambling machines, gambling games on the internet and via telecommunication network; computer systems; computer operating system software; computer terminals; interactive terminals; multimedia terminals; electronic terminals for generating lottery tickets; interactive touch screen terminals; computer touchscreens; electronic display panels; liquid crystal display screens; digital signage display panels; multimedia software; multimedia apparatus and instruments; interactive multimedia software for playing games; computer screens; LCD large-screen displays; liquid crystal displays [LCDs] for home theatres; media streaming software; computer application software for streaming

audio-visual media content via the internet; computer gaming software; software drivers; virtual reality software; games software; entertainment software for computer games; computer programs for network management; electronic lottery tickets; computer software platforms; operating systems; interactive computer systems; operating system programs; computer game software for use with on-line interactive games; interactive casino games provided through a computer or mobile platform; electronic ticket examination machines; software for slot machines, betting software, software for video slot games, for casino games, for gambling and bingo games, provided online or through computer networks and that can be played on any type of computer device, including arcade games, personal computers, portable devices and mobile phones; software; computer software packages; computer software, recorded.

**28** Gaming machines for gambling; chips for gambling; mah-jong; arcade games; gambling machines operating with coins, notes and cards; games; electronic games; parlor games; gaming chips; gaming tables; slot machines [gaming machines]; LCD game machines; slot machines and gaming devices; coin-operated amusement machines; roulette chips; poker chips; chips and dice [gaming equipment]; gaming equipment for casinos; roulette tables; gaming roulette wheels; casino games; gambling machines and amusement machines, automatic and coin-operated; coin-operated amusement machines and/or electronic coin-operated amusement machines with or without the possibility of gain; boxes for coin-operated amusement machines, slot machines and gaming machines; electronic or electrotechnical amusement machines and apparatus, gaming machines, coin-operated entertainment machines; housings for coin-operated amusement machines, gaming equipment, gaming machines, machines for gambling; electropneumatic and electrical gambling machines (slot machines); lottery games; electronic targets for games and sports; parlor game equipment and accessories therefor, included in this class, in particular gaming tokens, chips and marbles; parlor games, game apparatus and equipment and accessories therefor, included in this class, in particular electronic targets, backgammon games, scratch cards, playing cards, lottery cards, dice; lottery tickets; printed lottery tickets; lottery scratch cards; scratch cards for playing lottery games.



(540)

Note: Opposition period for this trademark expires on **06.03.2026**

---

(210) 1842607;

(220) 26.12.2024

(731) Euro Games Technology Ltd. Panorama Sofia Str. 6, Richhill Business Center, ground floor BG-1766 Vitosha Region, Sofia, Bulgaria.

(511) Int.Cl. 09, 28

(510):

**09** Operating computer software for main frame computers; monitors (computer hardware); computer hardware; apparatus for recording images; monitors (computer programs); computer game programs; recorded computer game programs; apparatus for recording, transmission or reproduction of sound or images; communications servers (computer hardware); electronic components for gambling machines; computer application software featuring games and gaming; computer software for the administration of on-line games and gaming; computer hardware for games and gaming; computer systems; computer operating system software; computer terminals; interactive terminals; multimedia terminals; electronic terminals for generating lottery tickets; interactive touch screen terminals; computer touchscreens; electronic display panels; liquid crystal display screens; digital signage display panels; multimedia software; multimedia apparatus and instruments; interactive multimedia software for playing games; computer screens; lcd large-screen displays; liquid crystal displays [lcds] for home theatres; media streaming software; computer application software for streaming audio-visual media content via the internet; computer gaming software; software; computer software packages; computer software, recorded; software drivers; virtual reality software; games software; entertainment software for computer games; computer programs for network management; electronic lottery tickets; computer software platforms; operating systems; interactive computer systems; operating system programs; computer game software for use with on-line interactive games; interactive casino games provided through a computer or mobile platform; electronic ticket

examination machines; software for slot machines, betting software, software for video slot games, for casino games, for gambling and bingo games, provided online or through computer networks and that can be played on any type of computer device, including arcade games, personal computers, portable devices and mobile phones; computer hardware and software for gambling, gambling machines, gambling games on the internet and via telecommunication network.

**28** Gaming machines for gambling; chips for gambling; mah-jong; arcade games; gambling machines operating with coins, notes and cards; games; electronic games; parlor games; gaming chips; gaming tables; slot machines [gaming machines]; LCD game machines; slot machines and gaming devices; coin-operated amusement machines; roulette chips; poker chips; chips and dice [gaming equipment]; gaming equipment for casinos; roulette tables; gaming roulette wheels; casino games; gambling machines and amusement machines, automatic and coin-operated; coin-operated amusement machines and / or electronic coin-operated amusement machines with or without the possibility of gain; boxes for coin-operated amusement machines, slot machines and gaming machines; electronic or electrotechnical amusement machines and apparatus, gaming machines, coin-operated entertainment machines; housings for coin-operated amusement machines, gaming equipment, gaming machines, machines for gambling; electropneumatic and electrical gambling machines (slot machines); lottery games; electronic targets for games and sports; parlor game equipment and accessories not included in other classes, in particular tokens, chips, marbles; parlor games, apparatus, equipment and accessories therefor, not included in other classes, in particular electronic targets, backgammon, scratch cards, playing cards, lottery cards, dice; lottery tickets; printed lottery tickets; lottery scratch cards; scratch cards for playing lottery games.

(540) **Shining Bells**

Note: Opposition period for this trademark expires on **06.03.2026**

---

(111) 639/2017; (151) 21.04.2017.

(310) (320) (330)

(511) Int. Cl.5.

(540) **TERBI SPRAY**

(732) Cipla Limited of Cipla House, Peninsula Business Park, Ganpatrao Kadam Marg, Lower Parel, Mumbai-400013, Maharashtra, India.

---

(111) 1370/2018; (151) 12.09.2018.

(310) (320) (330)

(511) Int. Cl.12.

(540) **JOKITO (and logo)**

(732) Liu Lei of Room 1102, NO. 6, Bai Yun District, Guangzhou, Peoples Republic of China.

---

(111) 1615/2023; (151) 19.09.2023.

(310) (320) (330)

(511) Int. Cl.25.

(540) **ZamCables (and logo)**

(732) Inventta Energy Zambia Limited of Suite 3, F110A/3, Musonda Ngosa Road, Villa Elizabetha, Lusaka, Zambia.

---

(111) 1616/2023; (151) 19.09.2023.

(310) (320) (330)

(511) Int. Cl.16.

(540) **ZamCables (and logo)**

(732) Inventta Energy Zambia Limited of Suite 3, F110A/3, Musonda Ngosa Road, Villa Elizabetha, Lusaka, Zambia.

---

(111) 2217/2023; (151) 30.11.2023.

(310) (320) (330)



(511) Int. Cl.16.

(540) **NHIMA and Logo (and logo)**

(732) National Health Insurance Management Authority (NHIMA) of Stand Number 27396, Public Service Pensions Fund Building, Alick Nkhata Road, Longacres Mall, Lusaka, Zambia.

---

(111) 134/2024; (151) 24.01.2024.

(310) (320) (330)

(511) Int. Cl.32.

(540) **AKSHARA (pure drinking water) LABEL (and logo)**

(732) Silicon Industries Limited of Plot No. LUS/9542, Off Katanga Road, Industrial Area, Lusaka, Zambia.

---

(111) 390/2024; (151) 01.03.2024.

(310) (320) (330)

(511) Int. Cl.29.

(540) **CHISAMBA RANCHING & CROPPING LIMITED (and logo)**

(732) CHISAMBA RANCHING & CROPPING LIMITED of Farm No. 452a/b Leopards Hill Road, P.O. Box 30796, Lusaka, Zambia.

---

(111) 759/2024; (151) 30.04.2024.

(310) (320) (330)

(511) Int. Cl.8.

(540) **PRO ACTION SPORT (and logo)**

(732) Pro-Action Sports of Plot No. C/22/737, Emmasdale, Lusaka, Zambia.

---

(111) 760/2024; (151) 30.04.2024.

(310) (320) (330)

(511) Int. Cl.21.

(540) **PRO ACTION SPORT (and logo)**

(732) Pro-Action Sports of Plot No. C/22/737, Emmasdale, Lusaka, Zambia.

---

(111) 761/2024; (151) 30.04.2024.

(310) (320) (330)

(511) Int. Cl.28.

(540) **PRO ACTION SPORT (and logo)**

(732) Pro-Action Sports of Plot No. C/22/737, Emmasdale, Lusaka, Zambia.

---

(111) 779/2024; (151) 30.04.2024.

(310) (320) (330)

(511) Int. Cl.16.

(540) **ROYALTY LAUNDRY LIMITED AND LABEL (and logo)**

(732) Royalty Laundry Limited of Plot No. 65, Off Palm Drive, Chelstone, Lusaka, Zambia.

---

(111) 851/2024; (151) 08.05.2024.

(310) (320) (330)

(511) Int. Cl.16.

(540) **THE MYRIAD LOOK (and logo)**

(732) Caroline Phiri-Mwiinde of L/19897/M/A/23, Lusaka South, Lusaka, Zambia.

---

(111) 852/2024; (151) 08.05.2024.

(310) (320) (330)

(511) Int. Cl.16.

(540) **MYRIOI INVESTMENTS LIMITED (and logo)**

(732) Myrioi Investments Limited of L/19897/M/A/23, Lusaka South, Zambia.

---

(111) 861/2024; (151) 09.05.2024.

(310) (320) (330)

(511) Int. Cl.21.

(540) **BEE**

(732) ACADEMY BRUSHWARE (PTY) LTD of 38, 5th Avenue, Bredell, Ext 15, Kempton Park, Gauteng, South Africa.

---

(111) 1030/2024; (151) 30.05.2024.

(310) (320) (330)

(511) Int. Cl.25.

(540) **JACWOS (and logo)**

(732) Joshua Chabala of 774, Garden house, Lusaka, Zambia.

---

(111) 1185/2024; (151) 20.06.2024.

(310) (320) (330)

(511) Int. Cl.16.

(540) **SIXTY THREE AUTO (and logo)**

(732) Sixty Three Auto Limited of Plot No. S/Lusaka/30 09360, Mass media, Thabo Mbeki Road, Zambia.

---

(111) 1357/2024; (151) 15.07.2024.

(310) (320) (330)

(511) Int. Cl.29.

(540) **OLIVOILA**

(732) Wilmar International Limited of 28 Biopolis Road, Singapore 138568, Singapore.

---

(111) 1435/2024; (151) 24.07.2024.

(310) (320) (330)

(511) Int. Cl.29.

(540) **DELIMORE AND LABEL (and logo)**

(732) Palermo Distributors Limited of Plot No. 397A Chipwenupwenu Road, Makeni, Lusaka, Zambia.

---

(111) 1436/2024; (151) 24.07.2024.

(310) (320) (330)

(511) Int. Cl.16.

(540) **DELIMORE AND LABEL (and logo)**

(732) Palermo Distributors Limited of Plot No. 397A Chipwenupwenu Road, Makeni, Lusaka, Zambia.

---

(111) 1446/2024; (151) 25.07.2024.

(310) (320) (330)

(511) Int. Cl.14.

(540) **SELF-ADJUSTABLE RING**

(732) Eternal Jewellery Zambia Limited of Shop 4, Central Park, Cairo Road, Lusaka, Zambia.

---

(111) 1449/2024; (151) 26.07.2024.

(310) (320) (330)

(511) Int. Cl.32.

(540) **LIFEWAY SHOT BEETROOT (and logo)**

(732) Bigtree Beverages Limited of Plot No. 33607, Mumbwa Road, Light Industrial Area P.O. Box 30824, Lusaka, Zambia.

---

(111) 1450/2024; (151) 26.07.2024.

(310) (320) (330)

(511) Int. Cl.32.

(540) **LIFEWAY SHOT ALOE VERA (and logo)**

(732) Bigtree Beverages Limited of Plot No. 33607, Mumbwa Road, Light Industrial Area P.O. Box 30824, Lusaka, Zambia.

---

(111) 1451/2024; (151) 26.07.2024.

(310) (320) (330)

(511) Int. Cl.32.

(540) **LIFEWAY SHOT GINGER (and logo)**

(732) Bigtree Beverages Limited of Plot No. 33607, Mumbwa Road, Light Industrial Area P.O. Box 30824, Lusaka, Zambia.

---

(111) 1462/2024; (151) 29.07.2024.

(310) (320) (330)

(511) Int. Cl.32.

(540) **KINGSIP MINERAL WATER (and logo)**

(732) Royalty Mineral Water Solutions of Plot 65 Palm drive, Chelston, Zambia.

---

(111) 1464/2024; (151) 29.07.2024.

(310) (320) (330)

(511) Int. Cl.3.

(540) **APLUS (and logo)**

(732) Rumphi Enterprises Limited of Plot No. 8077 Subdivision of A Industrial Area, Lusaka, Zambia.

---

(111) 1465/2024; (151) 31.07.2024.

(310) (320) (330)

(511) Int. Cl.16.

(540) **MMT SUSTAINABILITY ESG ANDGREEN FINANCE SUMMIT  
AND**

**EXPO ZAMBIA (and logo)**

(732) MMT VENTURES HOLDINGS ZAMBIA LIMITED of Plot no. 34383/917, Brass Road, Kamwala South, Lusaka, Zambia.

---

(111) 1466/2024; (151) 31.07.2024.

(310) (320) (330)

(511) Int. Cl.16.

(540) **MMT SUSTAINABILITY MARATHON ZAMBIA RUNNING WITH  
A GREEN PURPOSE (and logo)**

(732) MMT VENTURES HOLDINGS ZAMBIA LIMITED of Plot no. 34383/917, Brass Road, Kamwala South, Lusaka, Zambia.

---

(111) 1467/2024; (151) 31.07.2024.

(310) (320) (330)

(511) Int. Cl.16.

(540) **MMT SUSTAINABLE VALUE BEYOND IMAGINATION (and logo)**

(732) MMT VENTURES HOLDINGS ZAMBIA LIMITED of Plot no. 34383/917, Brass Road, Kamwala South, Lusaka, Zambia.

---

(111) 1469/2024; (151) 31.07.2024.

(310) (320) (330)

(511) Int. Cl.16.

(540) **MMT IFRS EXPERIENCE (and logo)**

(732) MMT VENTURES HOLDINGS ZAMBIA LIMITED of Plot No. 34383/917, Brass Road, Kamwala South, Lusaka, Zambia.

---

(111) 1470/2024; (151) 31.07.2024.

(310) (320) (330)

(511) Int. Cl.16.

(540) **MMT CREATING SUSTAINABLE VALUE BEYOND IMAGINATION (and logo)**

(732) MMT VENTURES HOLDINGS ZAMBIA LIMITED of Plot No. 34383/917, Brass Road, Kamwala South, Lusaka, Zambia.

---

(111) 1471/2024; (151) 31.07.2024.

(310) (320) (330)

(511) Int. Cl.25.

(540) **MMT CREATING SUSTAINABLE VALUE BEYOND IMAGINATION (and logo)**

(732) MMT VENTURES HOLDINGS ZAMBIA LIMITED of Plot No. 34383/917, Brass Road, Kamwala South, Lusaka, Zambia.

---

(111) 1472/2024; (151) 31.07.2024.

(310) (320) (330)

(511) Int. Cl.16.

(540) **MMT SUSTAINABILITY ESG AND GREEN FINANCE SUMMIT  
AND EXPO ZAMBIA (and logo)**

(732) MMT VENTURES HOLDINGS ZAMBIA LIMITED of Plot No. 34383/917, Brass Road,  
Kamwala South, Lusaka, Zambia.

---

(111) 1473/2024; (151) 31.07.2024.

(310) (320) (330)

(511) Int. Cl.25.

(540) **MMT SUSTAINABILITY ESG AND GREEN FINANCE SUMMIT  
AND EXPO ZAMBIA (and logo)**

(732) MMT VENTURES HOLDINGS ZAMBIA LIMITED of Plot No. 34383/917, Brass Road,  
Kamwala South, Lusaka, Zambia.

---

(111) 1474/2024; (151) 31.07.2024.

(310) (320) (330)

(511) Int. Cl.16.

(540) **MMT SUSTAINABILITY MARATHON ZAMBIA RUNNING WITH  
A GREEN PURPOSE (and logo)**

(732) MMT VENTURES HOLDINGS ZAMBIA LIMITED of Plot No. 34383/917, Brass Road,  
Kamwala South, Lusaka, Zambia.

---

(111) 1475/2024; (151) 31.07.2024.

(310) (320) (330)

(511) Int. Cl.25.

(540) **MMT SUSTAINABILITY MARATHON ZAMBIA RUNNING WITH  
A GREEN PURPOSE (and logo)**

(732) MMT VENTURES HOLDINGS ZAMBIA LIMITED of Plot No. 34383/917, Brass Road,  
Kamwala South, Lusaka, Zambia.

---

(111) 1476/2024; (151) 31.07.2024.

(310) (320) (330)

(511) Int. Cl.16.

(540) **MMT IPSAS EXPERIENCE (and logo)**

(732) MMT VENTURES HOLDINGS ZAMBIA LIMITED of Plot No. 34383/917, Brass Road, Kamwala South, Lusaka, Zambia.

---

(111) 1520/2024; (151) 02.08.2024.

(310) (320) (330)

(511) Int. Cl.16.

(540) **SUSTAINABILITY MARATHON ZAMBIA**

(732) MMT VENTURES HOLDINGS ZAMBIA LIMITED of Plot No. 34383/917, Brass Road, Kamwala South, Lusaka, Zambia.

---

(111) 1521/2024; (151) 02.08.2024.

(310) (320) (330)

(511) Int. Cl.16.

(540) **SUSTAINABILITY ESG AND GREEN FINANCE SUMMIT AND EXPO ZAMBIA**

(732) MMT VENTURES HOLDINGS ZAMBIA LIMITED of Plot No. 34383/917, Brass Road, Kamwala South, Lusaka, Zambia.

---

(111) 1610/2024; (151) 14.08.2024.

(310) (320) (330)

(511) Int. Cl.

(540) **JAGUAR**

(732) Sai Krishna Industry Zambia Limited of 7176 Mukatasha Road, Industrial area, Lusaka, Zambia.

---

(111) 1651/2024; (151) 20.08.2024.

(310) (320) (330)

(511) Int. Cl.16.

(540) **FININSIGHT Zambia Limited (and logo)**

(732) FININSIGHT Zambia Limited of Plot No. 17 Mapepe Road, Olympia, Lusaka, Zambia.

---



(111) 1730/2024; (151) 28.08.2024.

(310) (320) (330)

(511) Int. Cl.31.

(540) **RELIANCE (and logo)**

(732) Oasis Overseas Zambia Limited of Plot No. 7, Off Mosi Road, Ibex Hill, Lusaka, Zambia.

---

(111) 1732/2024; (151) 28.08.2024.

(310) (320) (330)

(511) Int. Cl.24.

(540) **Bonjour (and logo)**

(732) Polytex Investments Limited of Plot No. 8034 Karachi Street, Kamwala, P.O. Box 35297, Lusaka, Zambia.

---

(111) 1733/2024; (151) 28.08.2024.

(310) (320) (330)

(511) Int. Cl.24.

(540) **Classic Congo wax (and logo)**

(732) Polytex Investments Limited of Shop No 8035 Karachi Street Kamwala, Lusaka, 10101, Zambia.

---

(111) 1768/2024; (151) 03.09.2024.

(310) (320) (330)

(511) Int. Cl.30.

(540) **DELIMORE (and logo)**

(732) Palermo Distributors Limited of Plot No. 397A, Chipwenupwenu Road, Makeni, Zambia.

---

(111) 1828/2024; (151) 16.09.2024.

(310) (320) (330)

(511) Int. Cl.1.

(540) **NANOGRO AND LABEL (and logo)**

(732) RKTC Overseas Investments Limited of 10117, Akashambatwa Road, Olympia, Lusaka, Zambia.

---

(111) 1829/2024; (151) 16.09.2024.

(310) (320) (330)

(511) Int. Cl.30.

(540) **BONJOY FIESTA & LABEL (and logo)**

(732) Trade Kings Limited of Plot No. 29361 Nampundwe Road, off Mumbwa Road, Light Industrial Area, P.O. Box 30824, Zambia.

---

(111) 1848/2024; (151) 19.09.2024.

(310) (320) (330)

(511) Int. Cl.3.

(540) **DERMASKIN**

(732) Angel Cosmetics of RCCM 14-B-01794, 17eme Rue Limited BP 7561, Kinshasa, Democratic Republic of Congo.

---

(111) 1850/2024; (151) 19.09.2024.

(310) (320) (330)

(511) Int. Cl.3.

(540) **INFINI CLEAR**

(732) Angel Cosmetics of RCCM 14-B-01794, 17eme Rue Limited BP 7561, Kinshasa, Democratic Republic of Congo.

---

(111) 1851/2024; (151) 19.09.2024.

(310) (320) (330)

(511) Int. Cl.3.

(540) **PERFECT WHITE**

(732) Angel Cosmetics of RCCM 14-B-01794, 17eme Rue Limited BP 7561, Kinshasa, Democratic Republic of Congo.

---

(111) 1888/2024; (151) 24.09.2024.

(310) (320) (330)

(511) Int. Cl.30.

(540) **PIK POK**

(732) Nyama Soya Limited of Plot No. 29381, Nampundwe Road, Light Industrial Area, P.O Box 30824, Lusaka, Zambia.

---

(111) 1896/2024; (151) 25.09.2024.

(310) (320) (330)

(511) Int. Cl.11.

(540) **LIPER ANDC LABEL (and logo)**

(732) Simba Electrical Limited of Plot No. 3263/M Mungwi Road, Lusaka, Zambia.

---

(111) 1897/2024; (151) 25.09.2024.

(310) (320) (330)

(511) Int. Cl.9.

(540) **LIPER AND LABEL (and logo)**

(732) Simba Electrical Limited of Plot No. 3263/M Mungwi Road, Lusaka, Zambia.

---

(111) 1898/2024; (151) 25.09.2024.

(310) (320) (330)

(511) Int. Cl.9.

(540) **AFRICAB AND LABEL (and logo)**

(732) Simba Electrical Limited of Plot No. 3263/M Mungwi Road, Lusaka, Zambia.

---

(111) 1928/2024; (151) 03.10.2024.

(310) (320) (330)

(511) Int. Cl.5.

(540) **ALGIC-P**

(732) MSN Laboratories Private Limited of MSN House C-24, Sanathnagar Industrial Estates, Hyderabad 500 018, Talengana, India.

---

(111) 1929/2024; (151) 03.10.2024.

(310) (320) (330)

(511) Int. Cl.5.

(540) **WELTEK CARDIO**

(732) MSN Laboratories Private Limited of MSN House C-24, Sanathnagar Industrial Estates, Hyderabad 500 018, Talengana, India.

---

(111) 1930/2024; (151) 03.10.2024.

(310) (320) (330)

(511) Int. Cl.5.

(540) **WELTEK JOINT**

(732) MSN Laboratories Private Limited of MSN House C-24, Sanathnagar Industrial Estates, Hyderabad 500 018, Talengana, India.

---

(111) 1931/2024; (151) 03.10.2024.

(310) (320) (330)

(511) Int. Cl.5.

(540) **BIRATO**

(732) MSN Laboratories Private Limited of MSN House C-24, Sanathnagar Industrial Estates, Hyderabad 500 018, Talengana, India.

---

(111) 1932/2024; (151) 03.10.2024.

(310) (320) (330)

(511) Int. Cl.5.

(540) **DAPAMET**

(732) MSN Laboratories Private Limited of MSN House C-24, Sanathnagar Industrial Estates, Hyderabad 500 018, Talengana, India.

---

(111) 1933/2024; (151) 03.10.2024.

(310) (320) (330)

(511) Int. Cl.5.

(540) **DAPAONE**

(732) MSN Laboratories Private Limited of MSN House C-24, Sanathnagar Industrial Estates, Hyderabad 500 018, Talengana, India.

---

(111) 1934/2024; (151) 03.10.2024.

(310) (320) (330)

(511) Int. Cl.5.

(540) **ESEM**

(732) MSN Laboratories Private Limited of MSN House C-24, Sanathnagar Industrial Estates, Hyderabad 500 018, Talengana, India.

---

(111) 1935/2024; (151) 03.10.2024.

(310) (320) (330)

(511) Int. Cl.5.

(540) **FENIFIB**

(732) MSN Laboratories Private Limited of MSN House C-24, Sanathnagar Industrial Estates, Hyderabad 500 018, Talengana, India.

---

(111) 1936/2024; (151) 03.10.2024.

(310) (320) (330)

(511) Int. Cl.5.

(540) **FERASIRO**

(732) MSN Laboratories Private Limited of MSN House C-24, Sanathnagar Industrial Estates, Hyderabad 500 018, Talengana, India.

---

(111) 1937/2024; (151) 03.10.2024.

(310) (320) (330)

(511) Int. Cl.5.

(540) **ILET B**

(732) MSN Laboratories Private Limited of MSN House C-24, Sanathnagar Industrial Estates, Hyderabad 500 018, Talengana, India.

---

(111) 1938/2024; (151) 03.10.2024.

(310) (320) (330)

(511) Int. Cl.5.

(540) **FLOXSAFE**

(732) MSN Laboratories Private Limited of MSN House C-24, Sanathnagar Industrial Estates, Hyderabad 500 018, Talengana, India.

---

(111) 1939/2024; (151) 03.10.2024.

(310) (320) (330)

(511) Int. Cl.5.

(540) **LEVANEXT**

(732) MSN Laboratories Private Limited of MSN House C-24, Sanathnagar Industrial Estates, Hyderabad 500 018, Talengana, India.

---

(111) 1940/2024; (151) 03.10.2024.

(310) (320) (330)

(511) Int. Cl.5.

(540) **MACROSAFE**

(732) MSN Laboratories Private Limited of MSN House C-24, Sanathnagar Industrial Estates, Hyderabad 500 018, Talengana, India.

---

(111) 1941/2024; (151) 03.10.2024.

(310) (320) (330)

(511) Int. Cl.5.

(540) **LONGRIDE**

(732) MSN Laboratories Private Limited of MSN House C-24, Sanathnagar Industrial Estates, Hyderabad 500 018, Talengana, India.

---

(111) 1942/2024; (151) 03.10.2024.

(310) (320) (330)

(511) Int. Cl.5.

(540) **LURATA**

(732) MSN Laboratories Private Limited of MSN House C-24, Sanathnagar Industrial Estates, Hyderabad 500 018, Talengana, India.

---

(111) 1943/2024; (151) 03.10.2024.

(310) (320) (330)

(511) Int. Cl.5.

(540) **MIBZO**

(732) MSN Laboratories Private Limited of MSN House C-24, Sanathnagar Industrial Estates, Hyderabad 500 018, Talengana, India.

---

(111) 1944/2024; (151) 03.10.2024.

(310) (320) (330)

(511) Int. Cl.5.

(540) **METSAFE**

(732) MSN Laboratories Private Limited of MSN House C-24, Sanathnagar Industrial Estates, Hyderabad 500 018, Talengana, India.

---

(111) 1945/2024; (151) 03.10.2024.

(310) (320) (330)

(511) Int. Cl.5.

(540) **MYELOPAST**

(732) MSN Laboratories Private Limited of MSN House C-24, Sanathnagar Industrial Estates, Hyderabad 500 018, Talengana, India.

---

(111) 1946/2024; (151) 03.10.2024.

(310) (320) (330)

(511) Int. Cl.5.

(540) **RANCV**

(732) MSN Laboratories Private Limited of MSN House C-24, Sanathnagar Industrial Estates, Hyderabad 500 018, Talengana, India.

---

(111) 1947/2024; (151) 03.10.2024.

(310) (320) (330)

(511) Int. Cl.5.

(540) **PULMOFIRST**

(732) MSN Laboratories Private Limited of MSN House C-24, Sanathnagar Industrial Estates, Hyderabad 500 018, Talengana, India.

---

(111) 2014/2024; (151) 09.10.2024.

(310) (320) (330)

(511) Int. Cl.9.

(540) **BMD (and logo)**

(732) Huasheng Science and Technology Company Limited of Plot 10832/M Great North Road, 10 miles, Chibombo, Zambia.

---

(111) 2016/2024; (151) 10.10.2024.

(310) (320) (330)

(511) Int. Cl.3.

(540) **POP**

(732) Angel Cosmetics of RCCM 14-B-01794 id Nat 01-314-N45196F, 17eme Rue Limited BP 7561 Kin 1, , Kinshasa, Democratic Republic of Congo.

---

(111) 2031/2024; (151) 10.10.2024.

(310) (320) (330)

(511) Int. Cl.9.

(540) **HS POWER CABLE (and logo)**

(732) Huasheng Science and Technology Company Limited of Plot 10832/M Great North Road, 10 miles, Chibombo, Zambia.

---

(111) 2121/2024; (151) 25.10.2024.

(310) (320) (330)



(511) Int. Cl.16.

(540) **WORKERS' COMPENSATION (and logo)**

(732) Workers' Compensation of Compensation House, Corner Broadway/Moffat Roads, Box 71534, Ndola, Zambia.

---

(111) 2124/2024; (151) 30.10.2024.

(310) (320) (330)

(511) Int. Cl.29.

(540) **HY- LINE**

(732) Hy- Line International of 1755 West Lakes Parkway, West Des Moines, Iowa 50266, U.S.A.

---

(111) 2125/2024; (151) 30.10.2024.

(310) (320) (330)

(511) Int. Cl.9.

(540) **SUNLONG (and logo)**

(732) Shenzeng Sunlong Technology Co., Limited of 501 Bohua Technology Park, No. 25, Huohuiluo Road., Zhangkengjing Community, Guanhu Street, Longhua District, Shenzhen, Guangdong Province, Peoples Republic of China.

---

(111) 2310/2024; (151) 18.11.2024.

(310) (320) (330)

(511) Int. Cl.5.

(540) **Dynalab International Zambia Label (and logo)**

(732) Dynalab International Zambia Limited of Plot 26, Joseph Mwila Road, Rhodes Park, Lusaka, Zambia.

---

(111) 2311/2024; (151) 18.11.2024.

(310) (320) (330)

(511) Int. Cl.1.

(540) **Dynalab International Zambia Label (and logo)**

(732) Dynalab International Zambia Limited of Plot 26, Joseph Mwila Road, Rhodes Park, Lusaka, Zambia.

---

(111) 2326/2024; (151) 21.11.2024.

(310) (320) (330)

(511) Int. Cl.9.

(540) **ZAMMONEY (and logo)**

(732) Biu Capital Limited of House No. 22, Mutende Road, Woodlands, Lusaka, Zambia.

---

(111) 2327/2024; (151) 21.11.2024.

(310) (320) (330)

(511) Int. Cl.16.

(540) **ZAMMONEY (and logo)**

(732) Biu Capital Limited of House No. 22, Mutende Road, Woodlands, Lusaka, Zambia

---

**STATUTORY NOTICES UNDER THE TRADE MARKS ACT (CAP. 401)**

**TRADE MARK REGISTRATIONS RENEWED IN FEBRUARY 2025(ND)**

THE FOLLOWING trade mark registrations listed below have been renewed in accordance with Section 25 of the Trade Marks Act for 14 years with effect from the date indicated in Code(156).

(111)	26/1990	
(156)	15.02.2025	
(540)		
(732)	Inter. Continental Hotels Corporation.	
(511)	Int.Cl.16	

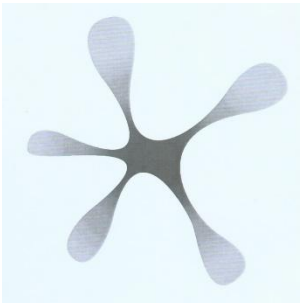
(111)	60/2004	
(156)	05.02.2025	
(540)	SPLAT (and logo)	
(732)	Unilever PLC	
(511)	Int.Cl. 3	

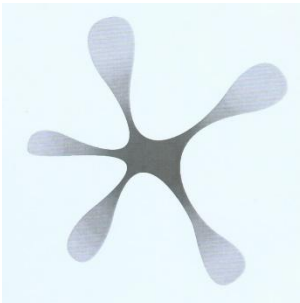
(111)	61/2004	
(156)	05.02.2025	
(540)	SPLAT (and logo)	
(732)	Unilever PLC	
(5511)	Int.Cl. 25	

(111)	101/2004	
-------	----------	--

(156)	05.02.2025	
(540)	CORPORATE U (and logo)	
(732)	Unilever Plc	
(511)	Int.Cl. 3	

(111)	103/2004	
(156)	05.02.2025	
(540)	UNILEVER (and logo)	
(732)	Unilever PLC	
(511)	Int.Cl. 7	

(111)	105/2004	
(156)	05.02.2025	
(540)	UNILEVER (and logo)	
(732)	Unilever PLC	
(511)	Int.Cl. 10	

(111)	106/2004	
(156)	05.02.2025	
(540)	UNILEVER (and logo)	

(732)	Unilever PLC	
(511)	Int.Cl. 11	

(111)	108/2004	
(156)	05.02.2025	
(540)	UNILEVER (and logo)	
(732)	Unilever PLC	
(511)	Int.Cl. 21	

(111)	109/2004	
(156)	05.02.2025	
(540)	UNILEVER (and logo)	
(732)	Unilever PLC	
(511)	Int.Cl.29	

(111)	110/2004	
(156)	05.02.2025	
(540)	UNILEVER (and logo)	

(732)	Unilever PLC	
(511)	Int.Cl.30	

(111)	111/2004	
(156)	05.02.2025	
(540)	UNILEVER (and logo)	
(732)	Unilever PLC	
(511)	Int.Cl. 31	

(111)	112/2004	
(156)	05.02.2025	
(540)	UNILEVER (and logo)	
(732)	Unilever PLC	
(511)	Int.Cl.32	

(111)	70/2004	
(156)	10.02.2025	
(540)		



(732)	Johnson & Johnson	
(511)	Int.Cl.5	

(111)	74/2004	
(156)	11.02.2025	
(540)	SUPERMATCH	
(732)	Potomac Tobacco Company Limited	
(511)	Int.Cl.34	

(111)	107/2004	
(156)	05.02.2025	
(540)	UNILEVER (and logo)	
(732)	Unilever PLC	
(511)	Int.Cl.16	

(111)	106/2004	
(156)	05.02.2025	
(540)	UNILEVER (and logo)	

(732)	Unilever PLC	
(511)	Int.Cl. 9	

(111)	43/2004	
(156)	03.02.2025	
(540)	JOHNNIE WALKER DEVICE (FACING RIGHT) (and logo)	
(732)	Diageo Brands B.V.,	
(511)	Int.Cl.33	
(111)	98/2018	
(156)	01.02.2025	
(540)	GLOBAL logo	
(732)	Sebang Global Battery Co., Ltd	
(511)	Int.Cl.9	

(111)	101/2018	
(156)	01.02.2025	
(540)	ECKANKAR (and logo)	



(732)	Eckankar	ECKANKAR
(511)	Int.Cl.9	

(111)	112/2018	
(156)	06.02.2025	
(540)	XYPEX (Stylized) (and logo)	
(732)	Xypex Chemical Corporation	
(511)	Int.Cl.1	

(111)	127/2018	
(156)	07.02.2025	
(540)	RIPNTIP	
(732)	Bimeda Amea Limited	
(511)	Int.Cl.31	

(111)	123/2018	
(156)	07.02.2025	
(540)	L & S (and logo)	

(732)	Guangdong Liansu Technology Industrial Co,	<b>L &amp; S</b>
(511)	Int.Cl.6	

(111)	124/2018	<b>L &amp; S</b>
(156)	07.02.2025	
(540)	L & S (and logo)	
(732)	Guangdong Liansu Technology Industrial Co	
(511)	Int.Cl.11	

(111)	125/2018	<b>L &amp; S</b>
(156)	07.02.2025	
(540)	L & S (and logo)	
(732)	Guangdong Liansu Technology Industrial Co	
(511)	Int.Cl19	

(111)	126/2018	<b>L &amp; S</b>
(156)	07.02.2025	
(540)	L & S (and logo)	
(732)	Guangdong Liansu Technology Industrial Co	

(511)	Int.Cl. 17	
-------	------------	--

(111)	153/2018	FARASI
(156)	13.02.2025	
(540)	FARASI (and logo)	
(732)	AMINA LIMITED	
(511)	Int.Cl. 5	

(111)	158/2018	ERVEBO
(156)	14.02.2025	
(9540)	ERVEBO (and logo)	
(732)	MERCK SHARP & DOHME CORP.	
(511)	Int.Cl.5	

(111)	172/2018	
(156)	16.02.2025	
(540)	LASHER DEVICE (B & W) (and logo)	
(732)	Vecto Trade 461 (Proprietary) Ltd	
(511)	Int.Cl.20	

(111)	173/2018	
(156)	16.02.2025	

<b>(540)</b>	<b>LASHER DEVICE (B &amp; W) (and logo)</b>		
<b>(732)</b>	<b>Vecto Trade (Proprietary) Ltd</b>	<b>461</b>	
<b>(511)</b>	<b>Int.Cl.12</b>		

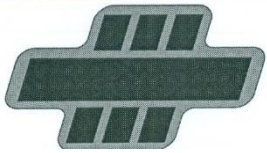
<b>(111)</b>	<b>174/2018</b>		
<b>(156)</b>	<b>16.02.2025</b>		
<b>(540)</b>	<b>LASHER DEVICE (B &amp; W) (and logo)</b>		
<b>(732)</b>	<b>Vecto Trade (Proprietary) Ltd</b>	<b>461</b>	
<b>(511)</b>	<b>Int.Cl.8</b>		

<b>(111)</b>	<b>170/2018</b>		
<b>(156)</b>	<b>16.02.2025</b>		
<b>(540)</b>	<b>LASHER</b>		
<b>(732)</b>	<b>Vecto Trade (Proprietary) Ltd</b>	<b>461</b>	
<b>(511)</b>	<b>Int.Cl.17</b>		

<b>(111)</b>	<b>194/2018</b>		
<b>(156)</b>	<b>21.02.2025</b>		
<b>(540)</b>	<b>FACEBOOK (and logo)</b>		

(732)	Meta Platforms, Inc.,	FACEBOOK
(511)	Int.Cl.9	

(111)	201/2018	
(156)	22.02.2025	
(540)	CEREVITA logo (colour) (and logo)	
(732)	SOCIETE DES PRODUCTS NESTLES S.A.	
(511)	Int.Cl.29	

(111)	198/2018	
(156)	22.02.2025	
(540)	EXCELLIUM logo (colour) (and logo)	
(732)	TotalEnergies SE	
(511)	Int.Cl.4	

File Series	119/2018	
File Status	22.02.2025	
Description of mark	EXCELLIUM logo (colour) (and logo)	

<b>Owner :</b>	<b>TotalEnergies SE</b>	
<b>(511)</b>	<b>Int.Cl.1</b>	

<b>(111)</b>	<b>200/2018</b>	
<b>(156)</b>	<b>22.02.2025</b>	
<b>(540)</b>	<b>CEREVITA logo (colour) (and logo)</b>	
<b>(732)</b>	<b>SOCIETE DES PRODUCTS NESTLES S.A.</b>	
<b>(511)</b>	<b>Int.Cl.30</b>	

<b>(111)</b>	<b>209/2018</b>	
<b>(156)</b>	<b>26.02.2025</b>	
<b>(540)</b>	<b>PREMUNI &amp; logo (and logo)</b>	
<b>(732)</b>	<b>Premuni Investment Limited</b>	
<b>(511)</b>	<b>Int.Cl.16</b>	

**STATUTORY NOTICES UNDER THE TRADE MARKS ACT (CAP. 401)**

**TRADE MARK REGISTRATIONS NOT RENEWED FOR JANUARY 2025(KC)**

NOTICE IS HEREBY GIVEN, in terms of Regulation 67, of the Trade Marks Regulations that the under mentioned trademarks will be removed from the Registrar unless the prescribed renewal fee is paid on Form TM No. 12 together with an additional fee on Form TM. No. 13 within one month from the date of this notice.

(111)	205/1962	
(156)	14.02.2025	
(540)	MCA (and logo)	
(732)	Universal City Studios LLC	
(511)	Int. Cl.9	
(111)	35/1976	<p align="center">STYROFOAM</p>
(156)	05.02.2025	
(540)	STYROFOAM	
(732)	The Dow Chemical Company	
(511)	Int. Cl.17	
(111)	58/1976	<p align="center">KING KORN</p>
(156)	25.02.2025	
(540)	KING KORN	
(732)	Tiger Food Brands Intellectual Property Holding Co (Pty) Ltd	
(511)	Int. Cl.30	
(111)	16/1990	
(156)	06.02.2025	

(540)	AGIL	AGIL
(732)	Quena Plant Protection N.V.	
(511)	Int. Cl.5	

(111)	24/1990	FORUM
(156)	15.02.2025	
(540)	FORUM	
(732)	Inter. Continental Hotels Corporation	
(511)	Int. Cl.16	

(111)	30/1990	BERKELEY
(156)	20.02.2025	
(540)	BERKELEY	
(732)	Batmark Limited	
(511)	Int. Cl.34	

(111)	42/2004	TODAY'S HARVEST
(156)	02.02.2025	
(540)	TODAY'S HARVEST	
(732)	Fanyate Milling Limited,	
(511)	Int. Cl.31	



(111)	63/2004	FREEDOM OF AFRICA PASS
(156)	05.02.2025	
(540)	FREEDOM OF AFRICA PASS	
(732)	Zambian Airways Limited	
(511)	Int. Cl.16	

(111)	2004	
<b>File Number</b>	115	
(156)	05.02.2025	
(540)	IDEAL (and logo)	
(732)	Kingdom Investments Limited	
(511)	Int. Cl.3	

(111)	116/2004	
(156)	05.02.2025	
(540)	IDEAL (and logo)	
(732)	Kingdom Investment Limited	
(511)	Int. Cl.29	

(111)	117/2004	
(156)	05.02.2025	
(540)	IDEAL (and logo)	
(732)	Klingdom Investment Limited	

<b>(511)</b>	Int. Cl.3	
--------------	-----------	--

<b>(111)</b>	64/2004	RIFT VALLEY
<b>(156)</b>	06.02.2025	
<b>(540)</b>	RIFT VALLEY	
<b>(732)</b>	Link Commodities	
<b>(511)</b>	Int. Cl.31	

<b>(111)</b>	65/2004	YANU-YANU
<b>(156)</b>	06.02.2025	
<b>(540)</b>	YANU-YANU	
<b>(732)</b>	Link Commodities	
<b>(511)</b>	Int. Cl.3	

(111)	67/2004	
(156)	09.02.2025	
(540)	SWIFT (and logo)	
(732)	California Beverages Limited	
(511)	Int. Cl.32	
(111)	73/2004	
(156)	12.02.2025	
(540)	NOVALYN (and logo)	
(732)	Pharmaceutical Limited Zambia	
(511)	Int. Cl.5	
(111)	74/2004	
(156)	12.02.2025	
(540)	NOVADERM (and logo)	
(732)	Pharmanova Zambia Limited	
(511)	Int. Cl.5	
(111)	75/2004	<p>NOVATRIM</p>
(156)	12.02.2025	
(540)	NOVATRIM	
(732)	Pharmanova Zambia Limited	
(511)	Int. Cl.5	

(111)	76/2004	NOVIDAR
(156)	12.02.2025	
(540)	NOVIDAR	
(732)	Pharmanova Zambia Limited	
(511)	Int. Cl.5	

(111)	77/2004	
(156)	12.02.2025	
(540)	PHIPPS GRIPE WATER (and logo)	
(732)	Pharmanova Zambia Limited	
(511)	Int. Cl.5	

(111)	89/2004	
(156)	24.02.2025	
(540)	MATHER+PLATT (and logo)	
(732)	Mather & Platt SA (PTY) Limited	
(511)	Int. Cl.7	

(111)	90/2004	DYNAMUTILIN
(156)	24.02.2025	
(540)	DYNAMUTILIN	
(732)	Elanco Tiergesundheits AG	
(511)	Int. Cl.5	

(111)	97/2004	
(156)	25.02.2025	
(540)	MOM'S HAIR OIL (and logo)	
(732)	N.R. Investment Limited	
(511)	Int. Cl.3	

(111)	98/2004	JUNIOR PUFFS
(156)	25.02.2025	
(540)	JUNIOR PUFFS	
(732)	N.R. INVESTMENTS LIMITED	
(511)	Int. Cl.30	

(111)	99/2004	
(156)	25.02.2025	
(540)	BIO-OIL (and logo)	
(732)	Geneva Laboratories Limited	
(511)	Int. Cl.3	

(111)	118/2005	JET MART
(156)	24.02.2025	
(540)	JET MART	
(732)	Foschini Retail Group Proprietary Limited	
(511)	Int. Cl.2	

(111)	99/2018	
(156)	25.02.2025	
(540)	ROCKET colour logo (and logo)	
(732)	Sebang Global Battery Co., Ltd	
(511)	Int. Cl.9	

(111)	100/2018	
(156)	01/02/2025	
(540)	ROCKET logo (and logo)	
(732)	Sebang Global Battery Co., Ltd	
(511)	Int. Cl.9	

(111)	103/2018	
(156)	02.02.2025	
(540)	Lion Device Mark (and logo)	
(732)	Mpande Limestone Limited	

(511)	Int. Cl.19	
(111)	104/2018	
(156)	02.02.2025	
(540)	Giraffe Device Mark (and logo)	
(732)	Mpande Limestone Limited	
(511)	Int. Cl.19	
(111)	102/2018	
(156)	02.02.2025	
(540)	CIRRUS ORGANIC FERTILIZER & LABEL (and logo)	
(732)	Mutekenya Livestock and Poultry Fram Limited	
(511)	Int. Cl.1	
(111)	116/2018	<p>KANKAN CHAIRS</p>
(156)	06.02.2025	
(540)	KANKAN CHAIRS (and logo)	
(732)	Aquamarine Investments Limited	
(511)	Int. Cl.20	
(111)	113/2018	
(156)	06.02.2025	
(540)	MELALITE INDIAN AYURVEDA & HERBS (and logo)	
(732)	Ivaan Industries Limited	



(511)	Int. Cl.3	
(111)	110/2018	
(156)	06.02.2025	
(540)	BRAVO PIZZA (and logo)	
(732)	Borders Capital Limited	
(511)	Int. Cl.30	

(111)	105/2018	
(156)	06.02.2025	
(540)	ACE GEOSYNTHETICS (and logo)	
(732)	Gold-Joint Industry Co., Ltd	
(511)	Int. Cl.19	

(111)	107/2018	
(156)	06.02.2025	
(540)	EZBRAID (and logo)	
(732)	Sehan Zambia Limited	
(511)	Int. Cl.26	

(111)	108/2018	
(156)	06.02.2025	
(540)	BRAVO ICE CREAM (and logo)	
(732)	Borders Capital Limited	
(511)	Int. Cl.29	

(111)	109/2018	
(156)	06.02.2025	
(540)	BRAVO CAFÉ (and logo)	
(732)	Borders Capital Limited	
(511)	Int. Cl.16	

(111)	111/2018	
(156)	06.02.2025	
(540)	BRAVO CHICKEN (and logo)	
(732)	Borders Capital Limited	
(511)	Int. Cl.29	

(111)	114/2018	<p><b>HAPPY NAKS</b></p>
(156)	06.02.2025	
(540)	HAPPY NAKS (and logo)	
(732)	Vikash Bedia	
(511)	Int. Cl.30	

(111)	121/2018	
(156)	07.02.2025	
(540)	CHERRYPICK (and logo)	
(732)	CHERRY-PICK LTD	
(511)	Int. Cl.31	

(111)	120/2018	
(156)	07.02.2025	
(540)	SAT & MAP OF AFRICA (and logo)	
(732)	Sexual Reproductive Health & Rights Africa Trust t/a SRHR Africa Trust	
(511)	Int. Cl.16	

(111)	122/2018	TALFANZA
(156)	07/02.2025	
(540)	TALFANZA	
(732)	Johnson & Johnson	
(511)	Int. Cl.5	

(111)	130/2018	CHALIMBANA
(156)	09.02.2025	
(540)	CHALIMBANA	
(732)	N.R Investments Ltd	
(511)	Int. Cl.30	

(111)	129/2018	
(156)	09.02.2025	
(540)	CHALIMBANA (and logo)	
(732)	N.R Investments Ltd	
(511)	Int. Cl.29	
(111)	147/2018	
(156)	12.02.2025	
(540)	TIR PREMIUM BRANDY LABEL (and logo)	
(732)	Rising Sun Investments Limited	
(511)	Int. Cl.33	
(111)	150/2018	
(156)	12.02.2025	
(540)	FOSUN PHARMA (and logo)	
(732)	Fosun Pharmaceutical Jiangsu Co Ltd	
(511)	Int. Cl.5	
(111)	135/2018	
(156)	12.02.2025	
(540)	ALL STATE(WHISKEY) (and logo)	
(732)	Kanugonda Goutham Reddy,Noble Spirits (PVT) LTD	
(511)	Int. Cl.33	

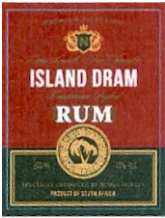
(111)	140/2018	
(156)	12.02.2025	
(540)	ISLAND DRAM RUM (and logo)	
(732)	Kanugonda Goutham Reddy,Noble Spirits (PVT) LTD	
(511)	Int. Cl.33	

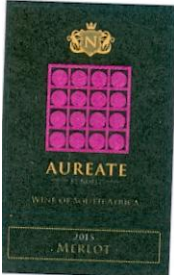
(111)	141/2018	
(156)	12.02.2025	
(540)	AUREATE (WINE) (and logo)	
(732)	Kanugonda Goutham Reddy,Noble Spirits (PVT) LTD	
(511)	Int. Cl.33	

(111)	142/2018	
(156)	12.02.2025	
(540)	OAKBERG (BRANDY) (and logo)	
(732)	Kanugonda Goutham Reddy,Noble Spirits (PVT) LTD	
(511)	Int. Cl.33	

(111)	143/2018	
(156)	12.02.2025	
(540)	SAILOR'S VODKA (and logo)	
(732)	Kanugonda Goutham Reddy,Noble Spirits (PVT) LTD	
(511)	Int. Cl.33	

(111)	144/2018	
(156)	12.02.2025	
(540)	KNR (PEAR SPIRIT COOLER) (and logo)	
(732)	Kanugonda Goutham Reddy, Noble Spirits (PVT) LTD	
(511)	Int. Cl.33	
(111)	145/2018	
(156)	12.02.2025	
(540)	SOLDIER PREMIUM BRANDY LABEL (and logo)	
(732)	Rising Sun Investments Limited	
(511)	Int. Cl.33	
(111)	148/2018	
(156)	12.02.2025	
(540)	SHOOTER VODKA LABEL (and logo)	
(732)	Rising Sun Investments Limited	
(511)	Int. Cl.33	
(111)	134/2018	
(156)	12.02.2025	
(540)	CAPRICORN BANK (and logo)	
(732)	CAPRICORN INVESTMENTS HOLDINGS LIMITED	
(511)	Int. Cl.16	

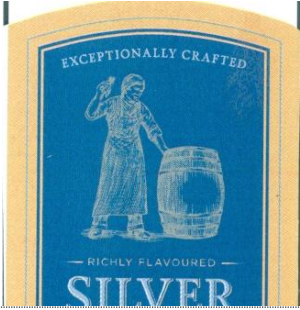
(111)	136/2018	
(156)	12.02.2025	
(540)	SILVER BARREL(WHISKY) (and logo)	
(732)	Kanugonda Goutham Reddy,Noble Spirits (PVT) LTD	
(511)	Int. Cl.33	

(111)	137/2018	
(156)	12.02.2025	
(540)	QUARTERBACK (WHISKY) (and logo)	
(732)	Kanugonda Goutham Reddy	
(511)	Int. Cl.33	

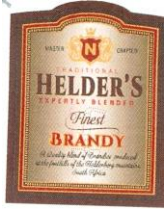
(111)	138/2018	
(156)	12.02.2025	
(540)	HELDER (BRANDY) (and logo)	
(732)	Kanugonda Goutham Reddy,Noble Spirits (PVT) LTD	
(511)	Int. Cl.33	



(111)	139/2018	
(156)	12.02.2025	
(540)	NIRVANA BITTERS (and logo)	
(732)	Kanugonda Goutham Reddy, Noble Spirits (PVT) LTD	
(511)	Int. Cl.33	

(111)	131/2018	Connector of positive change.
(156)	12.02.2025	
(540)	CONNECTOR OF POSITIVE CHANGE (and logo)	
(732)	CAPRICORN INVESTMENTS HOLDINGS LIMITED	
(511)	Int. Cl.16	

(111)	132/2018	Catalyst of Sustainable Opportunities
(156)	12.02.2025	
(540)	CATALYST OF SUSTAINABLE OPPORTUNITIES (and logo)	
(732)	CAPRICORN INVESTMENTS HOLDINGS LIMITED	
(511)	Int. Cl.16	

(111)	133/2018	
(156)	12.02.2025	
(540)	CAPRICORN GROUP (and logo)	
(732)	CAPRICORN INVESTMENTS HOLDINGS LIMITED	
(511)	Int. Cl.16	

(111)	154/2018	
(156)	13.02.2025	
(540)	BWINO (and logo)	
(732)	Osho Chemicals Zambia Limited	
(511)	Int. Cl.1	

(111)	155/2018	
(156)	14.02.2025	
(540)	RISE LOGO (and logo)	
(732)	Msoro Beverages Limited	
(511)	Int. Cl.32	

(111)	159/2018	
(156)	14.02.2025	
(540)	MARIANA (and logo)	
(732)	Four Grain Limited	
(511)	Int. Cl.1	

(111)	156/2018	<p>EBOVIZA</p>
(156)	14.02.2025	
(540)	EBOVIZA (and logo)	
(732)	MERCK SHARP & DOHME CORP	
(511)	Int. Cl.5	



(111)	157/2018	EBVAKSA
(156)	14.02.2025	
(540)	EBVAKSA (and logo)	
(732)	MERCK SHARP & DOHME CORP	
(511)	Int. Cl.5	

(111)	176/2018	MOBIL SUPER
(156)	16.02.2025	
(540)	MOBIL SUPER (and logo)	
(732)	EXXON MOBIL CORPORATION	
(511)	Int. Cl.4	

(111)	165/2018	
(156)	16.02.2025	
(540)	BPC (and logo)	
(732)	Banco de Poupança e Crédito S.A.	
(511)	Int. Cl.16	

(111)	177/2018	
(156)	19.02.2025	
(540)	SPICE WORLD (and logo)	
(732)	Noor Investment Limited	
(511)	Int. Cl.30	

(111)	179/2018	
(156)	19.02.2025	
(540)	FOUR SEASONS (and logo)	
(732)	Inntech Investment Limited	
(511)	Int. Cl.5	

(111)	178/2018		
(156)	19.02.2025		
(540)	SPICE WORLD (and logo)		
(732)	Retailability Limited	Proprietary	
(511)	Int. Cl.21		
(111)	184/2018		
(156)	20.02.2025		
(540)	CAPRICORN CONNECT (and logo)		
(732)	CAPRICORN INVESTMENTS HOLDINGS LIMITED		
(511)	Int. Cl.16		
(111)	182/2018		
(156)	20.02.2025		
(540)	M1 ROLLERMEAL (and logo)		
(732)	Mababe Milling Corporation Ltd		
(511)	Int. Cl.30		

(111)	183/2018	
(156)	20.02.2025	
(540)	M1 BREAKFAST (and logo)	
(732)	Mababe Milling Corporation Ltd	
(511)	Int. Cl.30	

(111)	191/2018	
(156)	21.02.2025	
(540)	Capricorn Mobile (and logo)	
(732)	Capricorn Investments Holdings Limited	
(511)	Int. Cl.16	

(111)	192/2018	
(156)	21.02.2025	
(540)	Capricorn Capital (and logo)	
(732)	Capricorn Investments Holdings Limited	
(511)	Int. Cl.16	





(111)	193/2018	
(156)	21.02.2025	
(540)	ZAMFIELD (and logo)	
(732)	NACRO, Henwood Chibombo Farm	
(511)	Int. Cl.29	

(111)	206/2018	
(156)	22.02.2025	
(540)	KANYALE MILLING (and logo)	
(732)	Kanyale Milling	
(511)	Int. Cl.30	

(111)	205/2018	
(156)	22.02.2025	
(540)	ZAMFIELD DRIED TOMATO (and logo)	
(732)	NACRO, Henwood Chibombo Farm	
(511)	Int. Cl.29	

(111)	196/2018	
(156)	22.02.2025	
(540)	PICK (PASSION FRUIT) (and logo)	
(732)	D.K. ENTERPRISES LIMITED	
(511)	Int. Cl.32	

(111)	197/2018	
(156)	22.02.2025	
(540)	PICK (PINEAPPLE) (and logo)	
(732)	D.K. ENTERPRISES LIMITED	
(511)	Int. Cl.32	

(111)	195/2018	
(156)	22.02.2025	
(540)	PICK (ORANGE) (and logo)	
(732)	D.K. ENTERPRISES LIMITED	
(511)	Int. Cl.32	

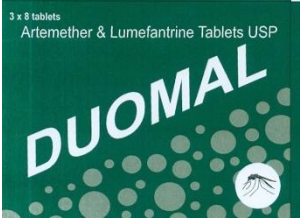
(111)	211/2018	
(156)	26.02.2025	
(540)	DUOMAL (and logo)	
(732)	JMB Pharmaceuticals PVT. LTD	
(511)	Int. Cl.5	

(111)	210/2018	
(156)	26.02.2025	
(540)	METROZ - 200 (and logo)	
(732)	JMB Pharmaceuticals PVT. LTD	
(511)	Int. Cl.5	

(111)	277/2018	<p>ATRA G</p>
(156)	28.02.2025	
(540)	ATRA G	
(732)	Vista Agrotech & Sciences Limited	
(511)	Int. Cl.1	

(111)	242/2018	FLORA
(156)	28.02.2025	
(540)	FLORA	
(732)	Vista Agrotech & Sciences Limited	
(511)	Int. Cl.1	

(111)	260/2018	DOLA
(156)	28.02.2025	
(540)	DOLA	
(732)	Vista Agrotech & Sciences Limited	
(511)	Int. Cl.5	

(111)	280/2018	AMAZE
(156)	28.02.2025	
(540)	AMAZE	
(732)	Vista Agrotech & Sciences Limited	
(511)	Int. Cl.5	

<b>(111)</b>	226/2018	<b>MEGA SHAKE</b>
<b>(156)</b>	28.02.2025	
<b>(540)</b>	MEGA SHAKE	
<b>(732)</b>	Vital Beverages Limited	
<b>(511)</b>	Int. Cl.32	

<b>(111)</b>	228/2018	<b>KOPALA BREW</b>
<b>(156)</b>	28.02.2025	
<b>(540)</b>	KOPALA BREW	
<b>(732)</b>	Kopala Meats Limited	
<b>(511)</b>	Int. Cl.32	

<b>(111)</b>	227/2018	<b>ELITE</b>
<b>(156)</b>	28.02.2025	
<b>(540)</b>	ELITE	
<b>(732)</b>	Elite Distributors Limited	
<b>(511)</b>	Int. Cl.16	

(111)	230/2018	NICOLUS
(156)	28.02.2025	
(540)	NICOLUS	
(732)	Vista Agrotech & Sciences Limited	
(511)	Int. Cl.5	

(111)	231/2018	NICOLUS
(156)	28.02.2025	
(540)	NICOLUS	
(732)	Vista Agrotech & Sciences Limited	
(511)	Int. Cl.1	

(111)	232/2018	DROPLIN
(156)	28.02.2025	
(540)	DROPLIN	
(732)	Vista Agrotech & Sciences Limited	
(511)	Int. Cl.5	

<b>(111)</b>	233/2018	DROPLIN
<b>(156)</b>	28.02.2025	
<b>(540)</b>	DROPLIN	
<b>(732)</b>	Vista Agrotech & Sciences Limited	
<b>(511)</b>	Int. Cl.1	

<b>(111)</b>	243/2018	CARBINE
<b>(156)</b>	28.02.2025	
<b>(540)</b>	CARBINE	
<b>(732)</b>	Vista Agrotech & Sciences Limited	
<b>(511)</b>	Int. Cl.5	

<b>(111)</b>	244/2018	CARBINE
<b>(156)</b>	28.02.2025	
<b>(540)</b>	CARBINE	
<b>(732)</b>	Vista Agrotech & Sciences Limited	
<b>(511)</b>	Int. Cl.1	

<b>(111)</b>	245/2018	STOREPHOS
<b>(156)</b>	14.02.2025	
<b>(540)</b>	STOREPHOS	
<b>(732)</b>	Vista Agrotech & Sciences Limited	
<b>(511)</b>	Int. Cl.5	

<b>(111)</b>	246/2018	WEETOX
<b>(156)</b>	05.02.1976	
<b>(540)</b>	WEETOX	
<b>(732)</b>	Vista Agrotech & Sciences Limited	
<b>(511)</b>	Int. Cl.1	

<b>(111)</b>	247/2018	STOREPHOS
<b>(156)</b>	28.02.2025	
<b>(540)</b>	STOREPHOS	
<b>(732)</b>	Vista Agrotech & Sciences Limited	
<b>(511)</b>	Int. Cl.1	



(111)	248/2018	SAAFEX
(156)	28.02.2025	
(540)	SAAFEX	
(732)	Vista Agrotech & Sciences Limited	
(511)	Int. Cl.5	

(111)	249/2018	SAAFEX (and logo)
(156)	28.02.2025	
(540)	SAAFEX (and logo)	
(732)	Vista Agrotech & Sciences Limited	
(511)	Int. Cl.1	

(111)	256/2018	DURION
(156)	28.02.2025	
(540)	DURION	
(732)	Vista Agrotech & Sciences Limited	
(511)	Int. Cl.5	

(111)	270/2018	REMOVE
<b>File Number</b>		
(156)	28.02.2025	
(540)	REMOVE	
(732)	Vista Agrotech & Sciences Limited	
(511)	Int. Cl.5	

(111)	271/2018	REMOVE
(156)	28.02.2025	
(540)	REMOVE	
(732)	Vista Agrotech & Sciences Limited	
(511)	Int. Cl.1	

(111)	272/2018	EMAMI
(156)	28.02.2025	
(540)	EMAMI	
(732)	Vista Agrotech & Sciences Limited	
(511)	Int. Cl.5	

<b>(111)</b>	273/2018	EMAMI
<b>(156)</b>	28.02.2025	
<b>(540)</b>	EMAMI	
<b>(732)</b>	Vista Agrotech & Sciences Limited	
<b>(511)</b>	Int. Cl.1	

<b>(111)</b>	274/2018	DURA G
<b>(156)</b>	28.02.2025	
<b>(540)</b>	DURA G	
<b>(732)</b>	Vista Agrotech & Sciences Limited	
<b>(511)</b>	Int. Cl.5	

<b>(111)</b>	275/2018	DURA G
<b>(156)</b>	28.02.2025	
<b>(540)</b>	DURA G	
<b>(732)</b>	Vista Agrotech & Sciences Limited	
<b>(511)</b>	Int. Cl.1	

(111)	276/2018	ATRA G
(156)	28.02.2025	
(540)	ATRA G	
(732)	Vista Agrotech & Sciences Limited	
(511)	Int. Cl.5	

(111)	278/2018	QUEST
(156)	28.02.2025	
(540)	QUEST	
(732)	Vista Agrotech & Sciences Limited	
(511)	Int. Cl.5	

(111)	279/2018	QUEST
(156)	28.02.2025	
(540)	QUEST	
(732)	Vista Agrotech & Sciences Limited	
(511)	Int. Cl.1	

(111)	281/2018	AMAZE
(156)	28.02.2025	
(540)	AMAZE	
(732)	Vista Agrotech & Sciences Limited	
(511)	Int. Cl.1	

(111)	282/2018	PREET
(156)	28.02.2025	
(540)	PREET	
(732)	Vista Agrotech & Sciences Limited	
(511)	Int. Cl.1	

(111)	283/2018	PREET
(156)	28.02.2025	
(540)	PREET	
(732)	Vista Agrotech & Sciences Limited	
(511)	Int. Cl.5	

(111)	252/2018	CYPRO
(156)	28.02.2025	
(540)	CYPRO	
(732)	Vista Agrotech & Sciences Limited	
(511)	Int. Cl.5	

(111)	264/2018	SUMO
(156)	28.02.2025	
(540)	SUMO	
(732)	Vista Agrotech & Sciences Limited	
(511)	Int. Cl.5	

(111)	229/2018	NICO
(156)	28.02.2025	
(540)	NICO	
(732)	Vista Agrotech & Sciences Limited	
(511)	Int. Cl.1	

(111)	234/2018	WEETOX
(156)	28.02.2025	
(540)	WEETOX	
(732)	Vista Agrotech & Sciences Limited	
(511)	Int. Cl.5	

(111)	235/2018	BREAK-UP
<b>File Number</b>		
(156)	28.02.2025	
(540)	BREAK-UP	
(732)	Vista Agrotech & Sciences Limited	
(511)	Int. Cl.5	

(111)	236/2018	BREAK-UP
(156)	28.02.2025	
(540)	BREAK-UP	
(732)	Vista Agrotech & Sciences Limited	
(511)	Int. Cl.1	

(111)	237/2018	HERBITOX
(156)	28.02.2025	
(540)	HERBITOX	
(732)	Vista Agrotech & Sciences Limited	
(511)	Int. Cl.5	

(111)	238/2018	HERBITOX
(156)	28.02.2025	
(540)	HERBITOX	
(732)	Vista Agrotech & Sciences Limited	
(511)	Int. Cl.1	

(111)	239/2018	OXYFEN
(156)	28.02.2025	
(540)	OXYFEN	
(732)	Vista Agrotech & Sciences Limited	
(511)	Int. Cl.5	



(111)	240/2018	OXYFEN
(156)	28.02.2025	
(540)	OXYFEN	
(732)	Vista Agrotech & Sciences Limited	
(511)	Int. Cl.1	

(111)	241/2018	FLORA
(156)	28.02.2025	
(540)	FLORA	
(732)	Vista Agrotech & Sciences Limited	
(511)	Int. Cl.5	

(111)	250/2018	MINER
(156)	28.02.2025	
(540)	MINER	
(732)	Vista Agrotech & Sciences Limited	
(511)	Int. Cl.5	

<b>(111)</b>	251/2018	MINER
<b>(156)</b>	28.02.2025	
<b>(540)</b>	MINER	
<b>(732)</b>	Vista Agrotech & Sciences Limited	
<b>(511)</b>	Int. Cl.1	

<b>(111)</b>	253/2018	CYPRO
<b>(156)</b>	28.02.2025	
<b>(540)</b>	CYPRO	
<b>(732)</b>	Vista Agrotech & Sciences Limited	
<b>(511)</b>	Int. Cl.1	

<b>(111)</b>	254/2018	GARATOX
<b>(156)</b>	28.02.2025	
<b>(540)</b>	GARATOX	
<b>(732)</b>	Vista Agrotech & Sciences Limited	
<b>(511)</b>	Int. Cl.5	

(111)	255/2018	GARATOX
(156)	28.02.2025	
(540)	GARATOX	
(732)	Vista Agrotech & Sciences Limited	
(511)	Int. Cl.1	

(111)	257/2018	DURION
(156)	28.02.2025	
(540)	DURION	
(732)	Vista Agrotech & Sciences Limited	
(511)	Int. Cl.1	

(111)	258/2018	NICO
(156)	28.02.2025	
(540)	NICO	
(732)	Vista Agrotech & Sciences Limited	
(511)	Int. Cl.5	

(111)	259/2018	DAY ONE
(156)	28.02.2025	
(540)	DAY ONE	
(732)	Vista Agrotech & Sciences Limited	
(511)	Int. Cl.1	

(111)	261/2018	DOLA
(156)	28.02.2025	
(540)	DOLA	
(732)	Vista Agrotech & Sciences Limited	
(511)	Int. Cl.1	

(111)	262/2018	METAMI
(156)	28.02.2025	
(540)	METAMI	
(732)	Vista Agrotech & Sciences Limited	
(511)	Int. Cl.5	

(111)	263/2018	METAMI
(156)	28.02.2025	
(540)	METAMI	
(732)	Vista Agrotech & Sciences Limited	
(511)	Int. Cl.1	

(111)	265/2018	SUMO
(156)	28.02.2025	
(540)	SUMO	
(732)	Vista Agrotech & Sciences Limited	
(511)	Int. Cl.1	

(111)	266/2018	BENTA
(156)	28.02.2025	
(540)	BENTA	
(732)	Vista Agrotech & Sciences Limited	
(511)	Int. Cl.5	



(111)	267/2018	BENTA
(156)	28.02.2025	
(540)	BENTA	
(732)	Vista Agrotech & Sciences Limited	
(511)	Int. Cl.1	

(111)	268/2018	MAX-D
(156)	28.02.2025	
(540)	MAX-D	
(732)	Vista Agrotech & Sciences Limited	
(511)	Int. Cl.5	

(111)	269/2018	MAX-D
(156)	28.02.2025	
(540)	MAX-D	
(732)	Vista Agrotech & Sciences Limited	
(511)	Int. Cl.1	

**STATUTORY NOTICES UNDER THE TRADE MARKS ACT (CAP 401 )**

**TRADE MARK REGISTRATIONS LAPSED FOR NON-RENEWAL. (MM)**

<b>(111)</b>	<b>1899/1948</b>	<b>BATA</b>
<b>(156)</b>	<b>Int. Cl. 7</b>	
<b>(511)</b>	<b>15/01/1948</b>	
<b>(540)</b>	<b>BATA</b>	
<b>(732)</b>	<b>Bata Brands SA</b>	
<b>(111)</b>	<b>1900/1948</b>	<b>BATA</b>
<b>(156)</b>	<b>15/01/1948</b>	
<b>(511)</b>	<b>Int. Cl.21</b>	
<b>(540)</b>	<b>BATA</b>	
<b>(732)</b>	<b>Bata Brands SA</b>	
<b>(111)</b>	<b>3/1962</b>	<b>BROOK BOND</b>
<b>-(156)</b>	<b>03/01/1962</b>	
<b>(511)</b>	<b>Int. Cl.</b>	
<b>(540)</b>	<b>BROOKE BOND</b>	
<b>(732)</b>	<b>ekaterra Group IP Holdings B.V.</b>	
<b>(111)</b>	<b>99/1962</b>	<b>RIVOTRIL</b>
<b>(156)</b>	<b>20/01/1962</b>	
<b>(511)</b>	<b>Int. Cl. 5</b>	
<b>(540)</b>	<b>RIVOTRIL</b>	
<b>(732)</b>	<b>Roche Products Limited</b>	
<b>(111)</b>	<b>101/1962</b>	
<b>(156)</b>	<b>20/01/1962</b>	



(511)	Int. Cl. 5	VALIUM
(540)	VALIUM	
(732)	Roche Products Limited	
(111)	1184/1962	TRASYLOL
(156)	20/01/1962	
(511)	Int. Cl.5	
(540)	TRASYLOL	
(732)	Bayer Aktiengesellschaft,	
(111)	135/1962	
(156)	20/01/1962	
(511)	Int. Cl. 31	
(540)	MINUTE MAID	
(732)	The Coca-Cola Company	

(111)	1/1976	
(156)	02/01/1976	
(511)	Int. Cl. 33	
(540)	BLACK & WHITE (and logo)	
(732)	Guinness united distillers & vintners B.V.,	
(111)	26/1976	
(156)	22/01/1990	

<b>(511)</b>	<b>Int. Cl. 7</b>	
<b>(540)</b>	<b>WIX</b>	
<b>(732)</b>	<b>Wix Filtration Corporation,</b>	

(111)	2/1990	
(156)	08/01/1990	
(511)	Int. Cl. 12	
(540)	ROCKY (and logo)	
(732)	Daihatsu Motor Co. Limited,	

(111)	17/1990	
(156)	08/01/1990	
(511)	3	
(540)	SIX CONTINENTS CLUB	
(732)	Inter. Continental Hotels Corporation,	

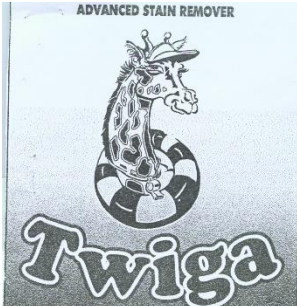
(111)	1/2004	
(156)	06/01/2004	
(511)	Int. Cl. 3	
Description of mark	TWIGA & GIRAFFE (and logo)	
Owner :	Twiga Chemicals Zambia Limited,	

(111)	3/2004	
(156)	07/01/2004	
(511)	Int. Cl. 30	
(540)	BLACK MAAMBA	
(732)	Californian Beverages Limited,	

(111)	4/2004	
(156)	07/01/2004	
(511)	Int. Cl. 3	
(540)	WHEN YOU NEED THE MAXIMUM MENTALLY AND PHYSICALLY	
(732)	Californian Beverages Limited	

File Series	5/2004	
(156)	08/01/2004	
(511)	Int. Cl. 3	
(540)	MAGIC SPEARMINT (and logo)	
(732)	Aru Industries Limited	

(111)	6/2004	
(156)	08/01/2004	
(511)	Int. Cl. 5	
(540)	ENTRUST	

<b>(732)</b>	<b>Dow Agrosciences LLC,</b>	
--------------	------------------------------	--

(111)	8/2004	
(156)	08/01/2004	
(511)	Int. Cl. 10	
(540)	JADELLE	
(732)	Schering OY,	
(111)	22/2004	
(156)	14/01/2004	
(511)	Int. Cl. 33	
(540)	ABSOLUT CUT	
(732)	The Absolut Company	

(111)	23/2004	
(156)	14/01/2004	
(511)	Int. Cl. 33	
(540)	ABSOLUT CUT BOTTLE (and logo)	
(732)	The Absolut Company	

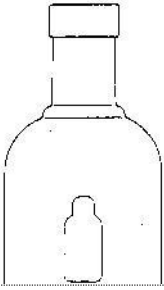
(111)	26/2004	
(156)	14/01/2004	
(511)	03/01/2018	
(540)	LEVEL BOTTLE (and logo)	
(732)	V & S Vin & Spirit Aktiebolag,,	

(111)	1/2018	
(156)	03/01/2018	
(511)	Int. Cl. 5	
(540)	REDEMVI	
(732)	Otsuka Pharmaceutical Co., Ltd,	
Representative :	,	

(111)	2/2018	
(156)	03/01/2018	
(511)	Int. Cl. 5	
(540)	CYDENITOR	
(732)	Otsuka Pharmaceutical Co., Ltd,	

<b>(111)</b>	<b>3/2018</b>	
<b>(156)</b>	<b>03/01/2018</b>	
<b>(511)</b>	<b>Int. Cl. 5.</b>	
<b>(540)</b>	<b>INQOVI</b>	
<b>(732)</b>	<b>Otsuka Pharmaceutical Co., Ltd,</b>	

<b>(111)</b>	<b>2018</b>	
<b>(156)</b>	<b>04/01/2018</b>	
<b>(511)</b>	<b>Int. Cl.19</b>	
<b>(540)</b>	<b>BTEE</b>	
<b>(732)</b>	<b>Goodfuture Investment Limited,</b>	

<b>(111)</b>	<b>10/2018</b>	
<b>(156)</b>	<b>08/01/2018</b>	
<b>(511)</b>	<b>Int. Cl.19</b>	
<b>(540)</b>	<b>OWOD (and logo)</b>	
<b>(732)</b>	<b>Owod Investments Development Limited,</b>	



(111)	2018	
(156)	08/01/2018	
(511)	Int. Cl.20	
(540)	SWEETDREAM (and logo)	
(732)	Connick Investments Limited,P	

(111)	19/2018	<p>CHOO</p>
(156)	09/01/2018	
(511)	Int. Cl. 3.	
(540)	CHOO (and logo)	
(732)	J. Choo Limited,	

(111)	14/2018	<p>CHOO</p>
(156)	09/01/2018	
(511)	Int. Cl. 3.	
(540)	CHOO (and logo)	
(732)	J. Choo Limited,	

<b>(111)</b>	<b>17/2018</b>	<b>CHOO</b>
<b>(156)</b>		
<b>(511)</b>	<b>09/01/2018</b>	
<b>(540)</b>	<b>CHOO (and logo)</b>	
<b>(732)</b>	<b>J. Choo Limited,</b>	

<b>(111)</b>	<b>18/2018</b>	<b>CHOO</b>
<b>(156)</b>	<b>09/01/2018</b>	
<b>(511)</b>	<b>Int. Cl. 25</b>	
<b>(540)</b>	<b>CHOO (and logo)</b>	
<b>(732)</b>	<b>J. Choo Limited,</b>	

(111)	20/2018	
(156)	09/01/2028	
(511)	Int. Cl.	
(540)	BLUEBERRY (READY FOR THE CHALLENGE ) LABEL (and logo)	
(732)	Greezone Zambia Limited,	

File Series	11/2018	
(156)	09/01/2018	
(511)	Int. Cl. 26.	
(540)	AMBER (and logo)	
(732)	Jiang Zeqian,	

(111)	12/2018	
(156)		
(511)	Int. Cl.26	
(540)	EMERALD (and logo)	
(732)	Jiang Zeqian,	

(111)	13/2018	
(156)	12/01/2018	
(511)	Int. Cl.26	
(540)	BLISS (and logo)	
(732)	Jiang Zeqian,	

(111)	34/2018	
(156)	11/01/2018	
(511)	Int. Cl.16	
(540)	AFROPOLOGIE (and logo)	
(732)	Afropologie,	

(111)	39/2018	
(156)	15/01/2018	
(511)	Int. Cl. 16	
(540)	SPJ (and logo)	
(7320)	SPJ Tecnology and General Trading Limited,	

<b>(111)</b>	<b>42/2018</b>	<b>LEXTEMY</b>
<b>(156)</b>	<b>16/01/2018</b>	
<b>(511)</b>	<b>Int. Cl.30</b>	
<b>(540)</b>	<b>LEXTEMY (and logo)</b>	
<b>(732)</b>	<b>MYLAN PHARMACEUTICALS PRIVATE LIMITED,</b>	

(111)	41/2018	
(156)	16/01/2018	
(511)	Int. Cl.30	
(540)	CHEETOS MOUSTACHE	
(732)	Pepsico INC,	

(111)	43/2018	
(156)	16/01/2018	
(511)	Int. Cl. 30	
(540)	CHEETOS MOUSACHE DEVICE (and logo)	
(732)	Pepsico INC,	

(111)	44/2018	
(156)	21/01/2018	
(511)	Int. Cl.9	
(540)	ZAMBEZII LABEL (and logo)	
(732)	Kea Lab Limited,	

(111)	45/2018	
(156)	19/01/2018	
(511)	Int. Cl.5.	
(540)	ZONDUTRIZ (and logo)	
(732)	Johnson & Johnson,	

(111)	46/2018	
(156)	19/01/2018	
(511)	Int. Cl. 9	
Description of mark	TAMBO (and logo)	
Owner :	Kbai International	

(111)	48/2018	<b>TALPAQTO</b>
(156)	19/01/2018	
(511)	Int. Cl.5	
(540)	TALPAQTO (and logo)	
(732)	Johnson & Johnson,	

(111)	49/2018	<b>SAFLENTO</b>
(156)	19/01/2018	
(511)	Int. Cl. 5	
(540)	SAFLENTO (and logo)	
(732)	Johnson & Johnson,	

(111)	50/2018	
(156)	22/01/2018	
(511)	Int. Cl. 20	
(540)	<b>GREATER CHINA SHOPPING CENTER LIMITED LOGO (and logo)</b>	
(732)	<b>Greater China Shopping Center Limited,</b>	



(111)	55/2018	
(156)	22/01/2018	
(511)	Int. Cl. 9	
(540)	HANKOOK ATLASBX (and logo)	
(732)	Hankook Tire Worldwide Co., Ltd	

(111)	56/2018	
(156)	22/01/2018	
(511)	Int. Cl. 12	
(540)	HANKOOK TECHNOLOGY GROUP (and logo)	
(732)	Hankook Tire Worldwide Co., Ltd,	

(111)	57/2018	
(156)	23/01/2018	
(511)	Int. Cl.5	
(540)	SUNGA MOYO (and logo)	
(732)	Sunga Pharmacy & Dispensing Chemist Limited,	

(111)	63/2018	
(156)	25/01/2018	
(511)	Int. Cl. 9	
(540)	TIKAMBE (and logo)	
(732)	Panafrica Distributors Limited,	

(111)	64/2018	
(156)	30/01/2018	
(511)	Registered	
(540)	LANDENI (and logo)	
(732)	Panafrica Distributors Limited,	

(111)	76/2018	
(156)	30/01/2018	
(511)	Int. Cl. 30	
(540)	GUMMY POP (and logo)	
(732)	Aisha Investment,	

(111)	72/2018	
(156)	30/01/2018	
(511)	Int. Cl. 9	
(540)	VIWA	
(732)	Shenzhen Zhi Yan Technology Co. Ltd.	

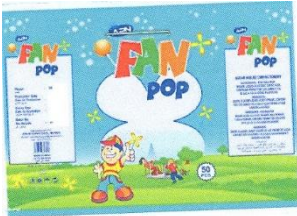
(111)	77/2018	
(156)	30/01/2018	
(511)	Int. Cl. 30	
(540)	FAN POP (and logo)	
(732)	Aisha Investments,	

(111)	78/2018	
(156)	30/01/2018	
(511)	Int. Cl. 30	
(540)	AFRICAN SOCCER POP (and logo)	
(732)	Aisha Investments,	

(111)	79/2018	
(156)	30/01/2018	
(511)	Int. Cl. 12	
(540)	DOLLYPOP (and logo)	
(732)	Aisha Investments,	
(111)	73/2018	
(156)	30/01/2018	
(511)	Int. Cl.	
(540)	RETRESKA	
(732)	Johnson & Johnson,	

(111)	71/2018	
(156)	30/01/2018	
(511)	Int. Cl. 9	
(540)	COMIO	
(732)	Huizhou Topwise Communication Co., Ltd,	

(111)	70/2018	
(156)	30/01/2018	
(511)	Int. Cl. 5	
(540)	NOVASAFE LABEL (and logo)	
(732)	Pharmanova (Z) limited,	

(111)	94/2018	
(156)	30/01/2018	
(511)	Int. Cl. 33	
(540)	BUTTERFLY LIMCA VODKA LABEL (and logo)	
(732)	Rising Sun Investments Limited,	



(111)	95/2018	
(156)	31/01/2018	
(511)	Int. Cl. 33	
Description of mark	MY CHOICE WHISKY LABEL (and logo)	
Owner :	Rising Sun Investments Limited,	

(111)	84/2018	
(156)	31/01/2018	
(511)	Int. Cl. 30	
(540)	YUMMY NAKS	
(732)	Trade Diva Candles (Z) Limited,	

STATUTORY NOTICES UNDER THE INDUSTRIAL DESIGNS ACT (NO. 22)

INDUSTRIAL DESIGNS FILED IN FEBRUARY 2025(AA)

The following industrial designs were filed on the date indicated in code (22)

(21) D2/2025; (22) 13.02.2025

(51) Int. Cl. 07-99

(54) A SUPPORT LEG FOR GANTRY CRANE.

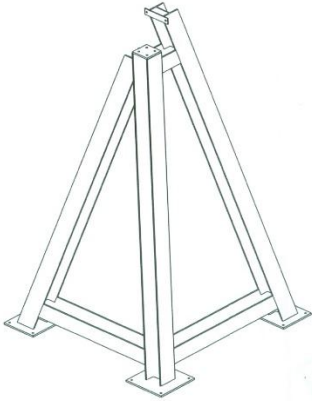

(71) Breza Engineering Limited, Plot No. 5260B Mukwa Road, Heavy Industrial Area, Lusaka, Zambia

(75) CHRISTOPHER, RUSSELL COOK & CO., Plot No 4658/A Chikwa Road, Opposite Old Magistrate Court, P.O Box 34091, Lusaka., Zambia

(21) D3/2025; (22) 14.02.2025

(51) Int. Cl. 07-99

(54) 750ml Plastic Bottle.

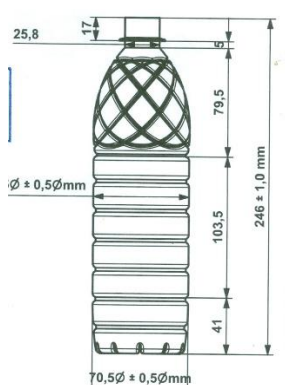

(71) (74) Indigo Plastic Limited, 7156 Mukatasha Road, Light Industrial Area, Lusaka, Zambia.

(21) D4/2025; (22) 14.02.2025

(51) Int. Cl. 07-99

(54) 28mm Alaska Bottle.





(71) (74) Nori Industries limited, Off Plot 17786B off Chilumbulu Road, Kamwala, Lusaka, Zambia

---

ARIPO FILINGS

ARIPO-REGISTERED DESIGN FILES DESIGNATING ZAMBIA FEBRUARY 2025.

The following industrial designs were filed on the date indicated in code (22)

(11) AP/D/2023/001825; (22) 30.10.2023

(51) Int. Cl. 19-08(14)

(54) **NICEONE LEMON PACKAGING LABEL**

(73) KOT BUILDING CENTER COMPANY LIMITED.

---

(11) AP/D/2023/001826; (22) 13.02.2025

(51) Int. Cl. 19-08(14)

(54) **NICEONE HONEY PACKAGING LABEL**

(73) KOT BUILDING CENTER COMPANY LIMITED

---

(11) AP/D/2024/001840; (22) 11.01.2024

(51) Int. Cl. 09-03(14)

(54) **MY GIRL PACKAGING LABEL**

(73) KOT BUILDING CENTER COMPANY LIMITED

---

11) AP/D/2024/001841; (22) 11.01.2024

(51) Int. Cl. 09-03(14)

(54) **AILYONS MULTIMEDIA SPEAKER PACKAGING LABEL**

(73) KOT BUILDING CENTER COMPANY LIMITED

---

11) AP/D/2024/001842; (22) 11.01.2024

(51) Int. Cl. 09-05(14)

(54) **KISSKIDS GOLD PACKAGING LABEL**

(73) KOT BUILDING CENTER COMPANY LIMITED

---

11) AP/D/2024/001843;

(22) 11.01.2024

(51) Int. Cl. 09-05(14)

(54) **KISSKIDS ALL DAY COMFORT PACKAGING LABEL**

(73) KOT BUILDING CENTER COMPANY LIMITED

---

11) AP/D/2024/001844;

(22) 11.01.2024

(51) Int. Cl. 09-05(14)

(54) **KISSKIDS SUPER DRY PACKAGING LABEL**

**(73)** KOT BUILDING CENTER COMPANY LIMITED

---

11) AP/D/2024/001845;

(22) 11.01.2024

(51) Int. Cl. 09-05(14)

(54) **KISSKIDS SUPER DRY PACKAGING LABEL**

(73) KOT BUILDING CENTER COMPANY LIMITED

11) AP/D/2024/001846;

(22) 13.02.2024

(51) Int. Cl. 09-03(14)

(54) **AILYONS LED TV PACKAGING LABEL**

(73) KOT BUILDING CENTER COMPANY LIMITED

---

11) AP/D/2024/001900;

(22) 05.06.2024

(51) Int. Cl. 09-02(14)

(54) **INTELLIGENT ENERGY STORAGE POWER SUPPLY**

(73) GUANGDONG SUMMIT TECHNOLOGY CO., LTD.

---

11) AP/D/2024/001904;

(22) 26.06.2024

(51) Int. Cl. 09-01(14)

(54) **BOTTLE**

(73) GUANGDONG SUMMIT TECHNOLOGY CO.,

The Registration below was advertised in the 25th June, 2020 Industrial Property Journal as lapsed. Kindly note that trade mark registration renewed in accordance with Section 25 of the Trade Marks Act for 14 years with effect from the date highlighted code (156).

(111) 293/2013; (156) 03.04.2020.

(511) Int Cl. 7.

(540) AARD

(732) Aard Equipment Zambia Limited

---

The Registration below was advertised in the 28<sup>th</sup> February, 2025 Industrial Property Journal without the logo. The correct details are in the highlighted code (540).

(111) 2273/2024; (156) 14.11.2024.

(731) Hyphen Technology (Proprietary) Limited, 6th Floor, 1st Place, Bankcity, Johannesburg, Gauteng, Republic of South Africa.

(740) Christopher, Russell Cook & Co, 4658/A Chikwa Road, Opposite Old Magistrate Court, P.O Box 34091, Lusaka

(511) Int Cl. 9.

(510) Scientific, research, navigation, surveying, photographic, cinematographic, audiovisual, optical, weighing, measuring, signalling, detecting, testing, inspecting, life-saving and teaching apparatus and instruments; apparatus and instruments for conducting, switching, transforming, accumulating, regulating or controlling the distribution or use of electricity; apparatus and instruments for recording, transmitting, reproducing or processing sound, images or data; recorded and downloadable media, computer software, blank digital or analogue recording and storage media; mechanisms for coin-operated apparatus; cash registers, calculating devices; computers and computer peripheral devices; diving suits, divers' masks, ear plugs for divers, nose clips for divers and swimmers, gloves for divers, breathing apparatus for underwater swimming; fire-extinguishing apparatus.

(540)



The Registration below was advertised in the 28<sup>th</sup> February, 2025 Industrial Property Journal without the logo. The correct details are in the highlighted code (540).

(111) 2274/2024;

(156) 14.11.2024.

(731) Hyphen Technology (Proprietary) Limited, 6th Floor, 1st Place, Bankcity, Johannesburg, Gauteng, Republic of South Africa.

(740) Christopher, Russell Cook & Co, 4658/A Chikwa Road, Opposite Old Magistrate Court, P.O Box 34091, Lusaka

(511) Int Cl. 16.

(510) Paper and cardboard; printed matter; bookbinding material; photographs; stationery and office requisites, except furniture; adhesives for stationery or household purposes; drawing materials and materials for artists; paintbrushes; instructional and teaching materials; plastic sheets, films and bags for wrapping and packaging; printers' type, printing blocks..

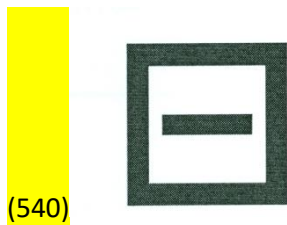

---

The Registration below was advertised in the 28<sup>th</sup> February, 2025 Industrial Property Journal with the following errors.

- Incorrect application number
- Incorrect date
- Missing agent details
- Missing Priority Date
- Missing applicant name and address
- Missing goods

The correct details are in the highlighted codes (111), (156), (310), (320), (731), (740) and (510)

(111) 1467/2024;

(156) 20.08.2024.

(310) 4261326

(320) 05.04.2024

(731) Antonio Puig, S.A., Plaza Europa, 46-48, 08902 L'Hospitalet de Llobregat, Barcelona, Spain

(740) Christopher, Russell Cook & Co, 4658/A Chikwa Road, Opposite Old Magistrate Court, P.O Box 34091, Lusaka

(511) Int Cl. 3.

(510) Non-medicated cosmetics and toiletry preparations; non-medicated dentifrices; perfumery, essential oils; bleaching preparations and other substances for laundry use; cleaning, polishing

and abrasive preparations; fragrances for personal use; eau de Cologne; eau de parfum; toilet water; scented water; perfumes; extracts of perfumes; non-medicated oral hygiene preparations; non-medicated body care and cleansing preparations; non-medicated body lotions, milks and creams; deodorants for personal use; antiperspirants for personal use; non-medicated soaps; non-medicated soaps for personal use; non-medicated soaps in liquid, solid or gel form for personal use; non-medicated bath gel; non-medicated shower gel; non-medicated bath preparations; non-medicated bath salts; non-medicated skin care preparations; exfoliants; talcum powder, for toilet use; perfumed powder; wipes, cotton and cloths impregnated with non-medicated cosmetic and fragranting lotions; non-medicated cosmetics, non-medicated toiletries and perfumery for the care and beauty of the eyelashes, eyebrows, eyes, lips and nails; non-medicated lip balm; nail polish; nail polish removers; adhesives for cosmetic purposes; non-medicated cosmetic preparations for slimming purposes; non-medicated hair preparations and treatments'; non-medicated shampoos; makeup preparations; make-up removing preparations; depilatory preparations; non-medicated shaving preparations; non-medicated pre-shaving preparations; non-medicated after-shave preparations; non-medicated beauty preparations; non-medicated cosmetic sun-tanning and self-tanning preparations; cosmetic kits; household fragrances; incense; aromatic potpourris; scented wood; preparations for perfuming linen; aromatic extracts; non-medicated animal grooming preparations; tailors' and cobblers' wax; leather and shoe cleaning and polishing preparations.



(540)

The Registrations below were advertised in the 28<sup>th</sup> February, 2025 Industrial Property Journal as renewed without the effective date of renewal. The correct details are in the highlighted code (156)

(111)	102/1962	CAROPHYLL
(156)	20.01.2025	
(540)		
(732)	DSM IP Assets B.V.	
(511)	Int.Cl.5	

(111)	25/1976	
(156)	22.01.2025	
(540)	DOW	
(732)	The Dow Chemical company	
(511)	Int.Cl.3	



KEY TO CODES USED IN KEY TO CODES USED IN THIS JOURNAL (WIPO ST.3) THIS JOURNAL(WIPO ST.3)

INID CODES FOR DETAILS OF ANNOUNCEMENTS

INID Code	Representation in Patent Announcements (ST.9)	Representation in Designs Announcements (ST.80)	INID Code	Representation in Trade Marks Announcements (ST.60)
(11)	Number of the patent	Registration number	(111)	Registration number
(15)	-	Date of the registration/renewal	(141)	Effective date of termination of registration
(17)	-	Expected duration of the registration/renewal	(151)	Effective date of registration of trade mark
(18)	-	Identification of the authority publishing or registering the industrial design (ST.3)	(156)	Effective date of renewal of registration
(19)	identification, of the office or organization publishing the document (ST.3)		(190)	Identification using the two-letter code of the authority registering the mark
(21)	Number(s) assigned to the application(s)	Application number	(210)	Serial number of the application
(22)	Date(s) of filing the application	Date of filing of the application	(220)	Application number Date of filing
(23)	Other date(s), including date of filing complete specification following provisional specification and date of exhibition	Name and place of exhibition, and date on which the industrial design was first exhibited there	(310)	Priority number
(24)	Date from which industrial property rights may have effect	Date from which the industrial design has effect	(320)	Priority date
(25)	Language in which published application was originally filed		(330)	Convention country
(26)	Language in which application is published		(510)	List of goods covered
(29)	-	Indication of the form in which the industrial design is filed	(511)	Class number of the international Nice Classification
(31)	Priority number	Priority number	(521)	Indication to the effect that the mark has acquired distinctiveness through use in trade
(32)	Priority date	Priority date		Indication that the mark has been cancelled for non-use
(33)	Convention country	Convention country	(525)	Disclaimer
(61)	International Patent Classification	Class mark of the International Locarno Classification	(526)	
	Title of the invention	Title of the design	(527)	Indications regarding use requirements
	Abstract or claim	Abstract of design	(529)	Indications regarding use limitations
(71)	Number and filing date of earlier independent application or grant	Number and filing date of registered current application depends under for extension of that design to other goods under section 10	(540)	Reproduction of trade mark
(72)	on which current application depends under section 31 as			Reproduction of the mark where the mark is represented in standard characters
(73)	application for the patent of addition		(541)	Reproduction of the mark where the mark is represented in non-standard characters
(74)	Name(s) and address(es) of applicants	Name(s) and address(es) of the applicant(s)	(551)	Indication to the effect that the mark is a collective mark, a certification mark or a guarantee mark
(75)	Name(s) of inventor(s) is known to be such	Name(s) of the creator(s) if known to be such	(558)	Mark consisting exclusively of one or several colors
(76)		Name(s) and address(es) of the owner(s)	(591)	Information concerning colors claimed
(78)			(641)	Number(s) of other related application(s)
			(646)	Number(s) of other related trade mark registration(s)
			(561)	Transliteration of the mark
			(566)	Translation of the mark or of words contained in the mark
			(730)	Name and address of the applicant or the holder of the registration
			(731)	Name(s) and address(es) of the applicant(s)
			(732)	Name and address of the holder of the registration
			(730)	

	Name(s) of grantee(s), holder(s), assignee(s) or owner(s) Name(s) and address(es) of local attorney(s) or agents Name(s) of inventor(s) who is (are) also applicants Name(s) of inventor(s) who is (are) also applicants & grantee(s)	Name(s) and address(es) of the representative(s)  Name(s) and address(es) of the new owner(s) in case of change in ownership		Name(s) and address(es) of local attorney(s) (740) Correspondence address of the applicant or proprietor where attorney in code (740) is unavailable (750) Licensee's name and address (791) Conditions and/or restrictions under the license (793)
--	--	--	--	---

**LETTER CODES (STATUS CODES) FOR HEADING OF ANNOUNCEMENTS (WIPO ST.17)**

Code	Representation	Code	Representation	Code	Representation
(AA)	New Application not yet published for public inspection.	(HK)	Erratum for an industrial property that is in a stage up to date of grant/registration.	(NE)	Request for restoration of registration of an IP Registered IP assigned.
(BB)	Application accepted and published by laying open for public inspection.	(KC)	Fee for renewal or extension of registration of an IP not paid for	(PC)	IP now open to free public use.
(CA)	Opposition invited from the public	(MC)	Full term of registration expired (for patents and designs only)	(PE) (QB)	Registration of license for use of a Registered IP.
(DC)	Amendment of the specification or claims accepted	(MM)	Termination of registration of an IP due to non-renewal.	(TH)	Correction or change in general
(FG)	New grant / registration of an Industrial Property (IP)	(NO)	Registration term of an IP renewed or extended		